

## PRODUCT FEATURES

- Low Forward Voltage
- High Surge Current Capability
- Low Leakage Current
- Low Inductance Package

## APPLICATIONS

- Field Supply For DC Motors
- Line Rectifiers For Transistorized AC Motor Controllers
- Non-controllable Rectifiers For AC/DC Converter
- UL:E332185

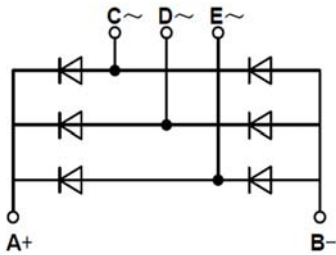

## Module Type

Module Type	$V_{RRM}$ Repetitive Peak Reverse Voltage	$V_{RSM}$ Non-Repetitive Peak Reverse Voltage	Unit
			V
MMD200F200X	2000	2100	

## ABSOLUTE MAXIMUM RATINGS( $T_C=25^{\circ}C$ unless otherwise specified)

Symbol	Parameter/Test Conditions		Values	Unit	
$I_D$	Output Current(D.C.)	Three phase, full wave, $T_c=95^{\circ}C$	200	A	
$I_{FSM}$	Non-Repetitive Surge Forward Current	1/2 cycle, 50HZ, peak value, $T_J=45^{\circ}C$	2000		
		1/2 cycle, 60HZ, peak value, $T_J=45^{\circ}C$	2200		
$I^2t$	For Fusing	1/2 cycle, 50HZ, peak value, $T_J=45^{\circ}C$	20.0	KA <sup>2</sup> S	
		1/2 cycle, 60HZ, peak value, $T_J=45^{\circ}C$	20.1		
$P_D$	Power Dissipation		1389	W	
$T_J$	Junction Temperature		-40 to +150	$^{\circ}C$	
$T_{STG}$	Storage Temperature Range		-40 to +125	$^{\circ}C$	
$V_{ISO}$	Isolation Breakdown Voltage	AC, 50Hz(R.M.S), t=1minute	3000	V	
Torque	Module to Sink	Recommended (M6)	3~5	Nm	
Torque	Module Electrodes	Recommended (M6)	3~5	Nm	
$R_{thJC}$	Junction to Case Thermal Resistance		per diode	0.54	K/W
			per module	0.09	
Weight			250	g	

MacMic Science & Technology Co., Ltd.

Add: #18, Hua Shan Zhong Lu, New District, Changzhou City, Jiangsu Province, P. R. of China

Tel.: +86-519-85163708 Fax: +86-519-85162291 Post Code: 213022 Website: www.macmicst.com

# MMD200F200X

## ELECTRICAL CHARACTERISTICS ( $T_C=25^\circ\text{C}$ unless otherwise specified)

Symbol	Parameter/Test Conditions	Min.	Typ.	Max.	Unit
$I_{RM}$	Maximum Reverse Leakage Current			0.5	mA
				$V_R = V_{RRM}, T_J = 125^\circ\text{C}$	
$V_F$	Forward Voltage Drop			1.45	V
$V_{TO}$	For power loss calculations only, $T_J = 125^\circ\text{C}$			0.85	V
$r_T$				3	m $\Omega$

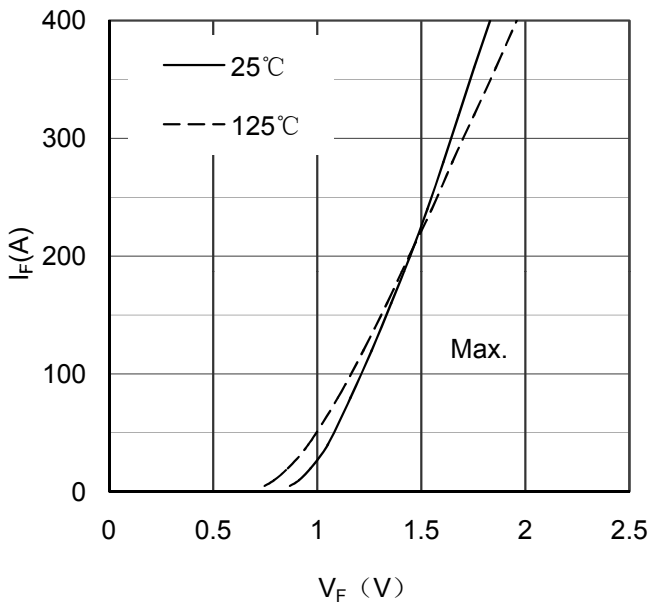

Figure 1. Forward Voltage Drop vs Forward Current

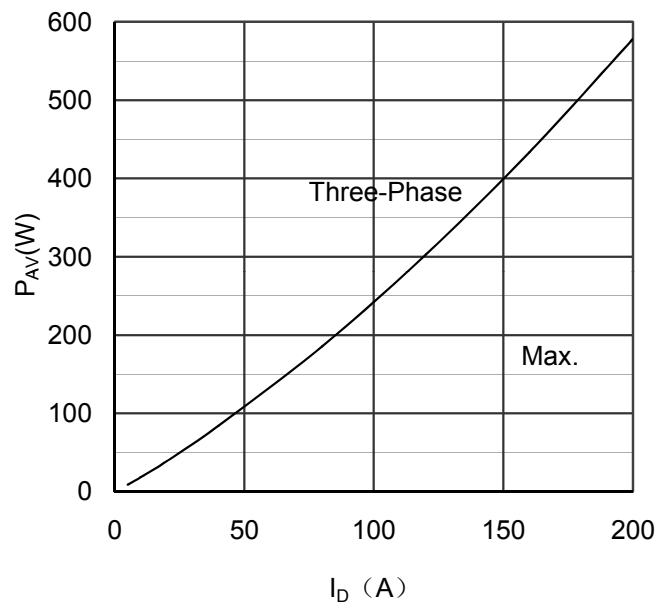

Figure 2. Power dissipation vs Output Current

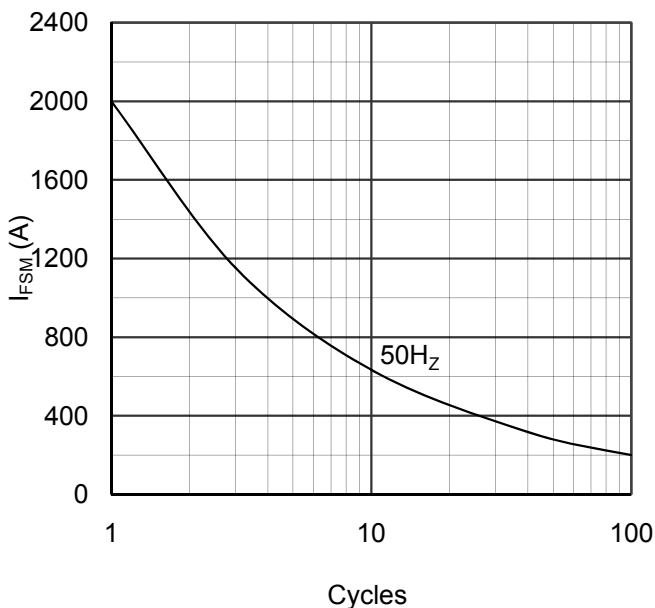

Figure 3. Max Non-Repetitive Forward Surge Current

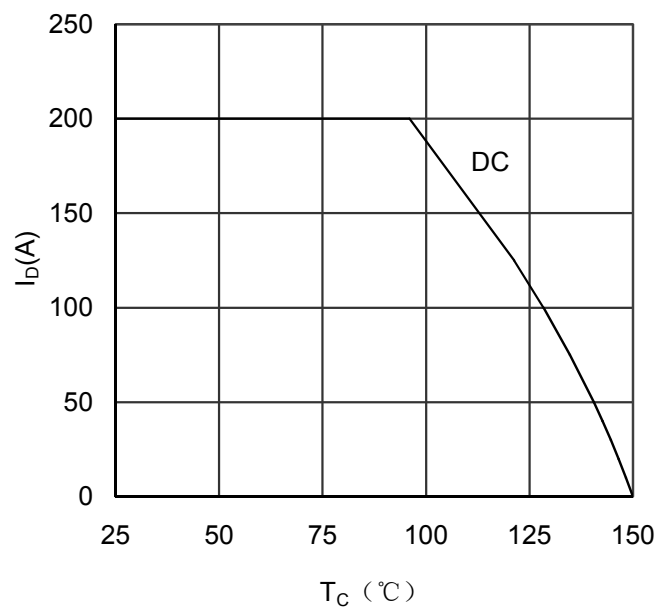
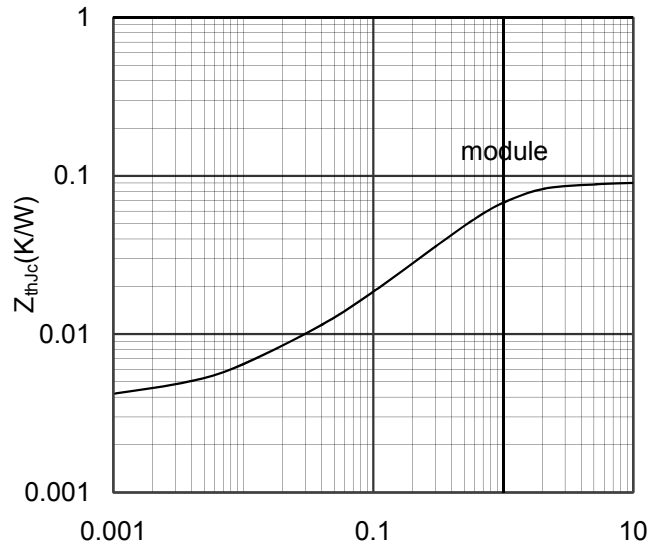
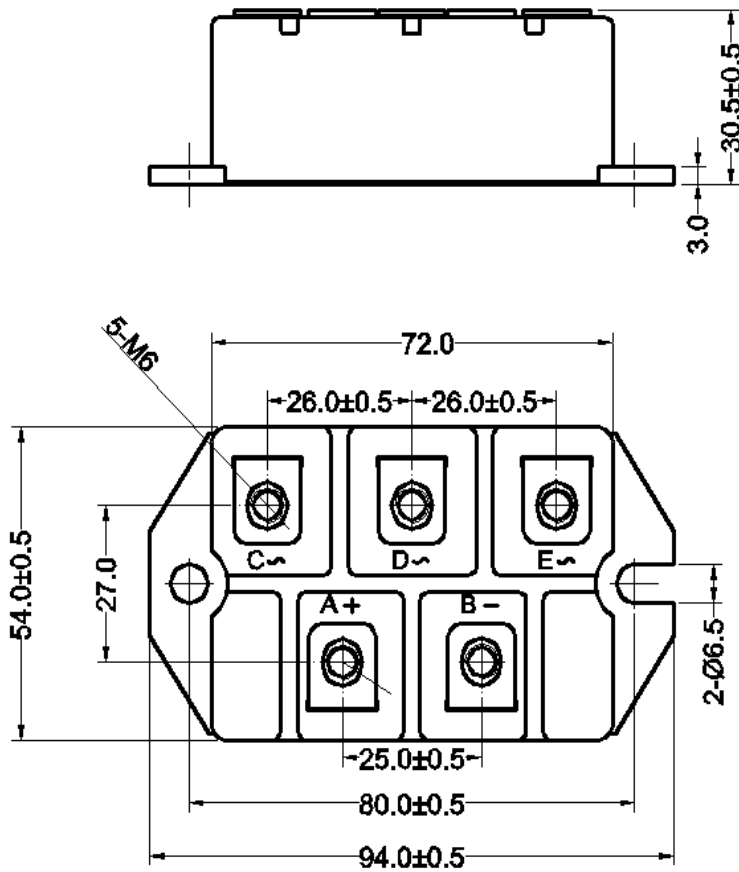

Figure 4. Output current vs Case temperature



Rectangular Pulse Duration(S)  
Figure 5. Transient Thermal Impedance



Dimensions in (mm)  
Figure 6. Package Outline