

## PRODUCT FEATURES

- IGBT<sup>3</sup> Chip(Trench+Field Stop technology)
- Low switching losses
- $V_{CE(sat)}$  with positive temperature coefficient
- Fast switching and short tail current
- Popular SOT-227 Package



## APPLICATIONS

- AC motor control
- Motion/servo control
- Inverter and power supplies

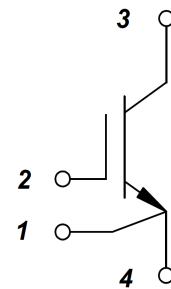

## IGBT

### ABSOLUTE MAXIMUM RATINGS( $T_C=25^\circ\text{C}$ unless otherwise specified)

Symbol	Parameter/Test Conditions		Values	Unit
$V_{CES}$	Collector Emitter Voltage	$T_J=25^\circ\text{C}$	1200	V
$V_{GES}$	Gate Emitter Voltage		$\pm 20$	
$I_C$	DC Collector Current	$T_C=25^\circ\text{C}, T_{Jmax}=150^\circ\text{C}$	140	A
		$T_C=80^\circ\text{C}, T_{Jmax}=150^\circ\text{C}$	100	
$I_{CM}$	Repetitive Peak Collector Current	$t_p=1\text{ms}$	200	
$P_{tot}$	Power Dissipation Per IGBT	$T_C=25^\circ\text{C}, T_{Jmax}=150^\circ\text{C}$	450	W

### MODULE CHARACTERISTICS( $T_C=25^\circ\text{C}$ unless otherwise specified)

Symbol	Parameter/Test Conditions		Values	Unit
$T_{Jmax}$	Max. Junction Temperature		150	°C
$T_{Jop}$	Operating Temperature		-40~125	
$T_{stg}$	Storage Temperature		-40~125	
$V_{isol}$	Isolation Breakdown Voltage	AC, 50Hz(R.M.S), $t=1\text{minute}$	3000	V
Torque	to heatsink	Recommended (M4)	0.7~1.1	Nm
	to terminal	Recommended (M4)	0.7~1.1	Nm
Weight			26.5	g

MacMic Science & Technology Co., Ltd.

Add: #18, Hua Shan Zhong Lu, New District, Changzhou City, Jiangsu Province, P. R. of China

# MMG100J120UZ6TN

## IGBT

### ELECTRICAL CHARACTERISTICS ( $T_C=25^\circ\text{C}$ unless otherwise specified)

Symbol	Parameter/Test Conditions		Min.	Typ.	Max.	Unit
$V_{GE(th)}$	Gate Emitter Threshold Voltage	$V_{CE}=V_{GE}, I_C=4\text{mA}$	5	5.8	6.5	V
$V_{CE(sat)}$	Collector Emitter Saturation Voltage	$I_C=100\text{A}, V_{GE}=15\text{V}, T_J=25^\circ\text{C}$		1.7	2.15	
		$I_C=100\text{A}, V_{GE}=15\text{V}, T_J=125^\circ\text{C}$		1.9		
$I_{CES}$	Collector Leakage Current	$V_{CE}=1200\text{V}, V_{GE}=0\text{V}, T_J=25^\circ\text{C}$			100	$\mu\text{A}$
		$V_{CE}=1200\text{V}, V_{GE}=0\text{V}, T_J=125^\circ\text{C}$			1	$\text{mA}$
$I_{GES}$	Gate Leakage Current	$V_{CE}=0\text{V}, V_{GE}=\pm 15\text{V}, T_J=25^\circ\text{C}$	-400		400	$\text{nA}$
$R_{gint}$	Integrated Gate Resistor			7.5		$\Omega$
$Q_g$	Gate Charge	$V_{CE}=600\text{V}, I_C=100\text{A}, V_{GE}=\pm 15\text{V}$		0.9		$\mu\text{C}$
$C_{ies}$	Input Capacitance	$V_{CE}=25\text{V}, V_{GE}=0\text{V}, f=1\text{MHz}$		7.1		$\text{nF}$
$C_{res}$	Reverse Transfer Capacitance				0.3	$\text{nF}$
$t_{d(on)}$	Turn on Delay Time	$V_{CC}=600\text{V}, I_C=100\text{A}$ $R_G=3.9\Omega,$ $V_{GE}=\pm 15\text{V},$ Inductive Load	$T_J=25^\circ\text{C}$		260	$\text{ns}$
			$T_J=125^\circ\text{C}$		290	$\text{ns}$
$t_r$	Rise Time	$V_{GE}=\pm 15\text{V},$ Inductive Load	$T_J=25^\circ\text{C}$		30	$\text{ns}$
			$T_J=125^\circ\text{C}$		50	$\text{ns}$
$t_{d(off)}$	Turn off Delay Time	$V_{CC}=600\text{V}, I_C=100\text{A}$ $R_G=3.9\Omega,$ $V_{GE}=\pm 15\text{V},$ Inductive Load	$T_J=25^\circ\text{C}$		420	$\text{ns}$
			$T_J=125^\circ\text{C}$		520	$\text{ns}$
$t_f$	Fall Time	$V_{GE}=\pm 15\text{V},$ Inductive Load	$T_J=25^\circ\text{C}$		70	$\text{ns}$
			$T_J=125^\circ\text{C}$		90	$\text{ns}$
$E_{on}$	Turn on Energy	$V_{CC}=600\text{V}, I_C=100\text{A}$ $R_G=3.9\Omega,$ $V_{GE}=\pm 15\text{V},$ Inductive Load	$T_J=25^\circ\text{C}$		7.8	$\text{mJ}$
			$T_J=125^\circ\text{C}$		10	$\text{mJ}$
$E_{off}$	Turn off Energy	$V_{GE}=\pm 15\text{V},$ Inductive Load	$T_J=25^\circ\text{C}$		8	$\text{mJ}$
			$T_J=125^\circ\text{C}$		10	$\text{mJ}$
$I_{SC}$	Short Circuit Current	$tp_{sc} \leq 10\mu\text{s}, V_{GE}=15\text{V}$ $T_J=125^\circ\text{C}, V_{CC}=900\text{V}$		400		A
$R_{thJC}$	Junction to Case Thermal Resistance ( Per IGBT )				0.28	$\text{K/W}$

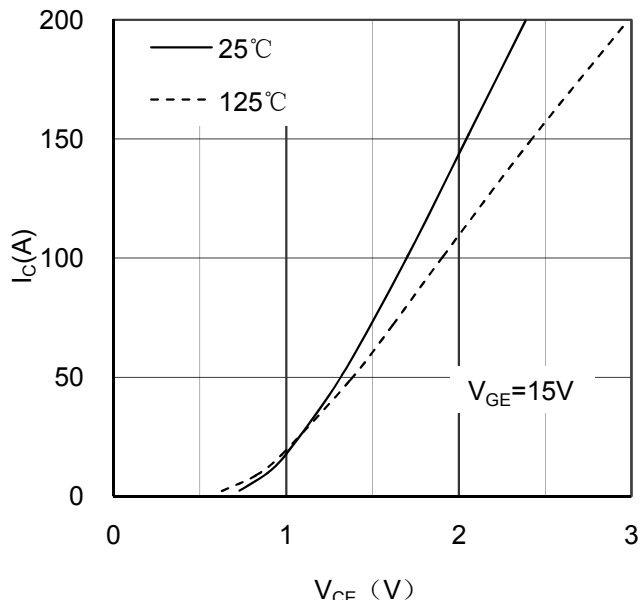

Figure 1. Typical Output Characteristics IGBT

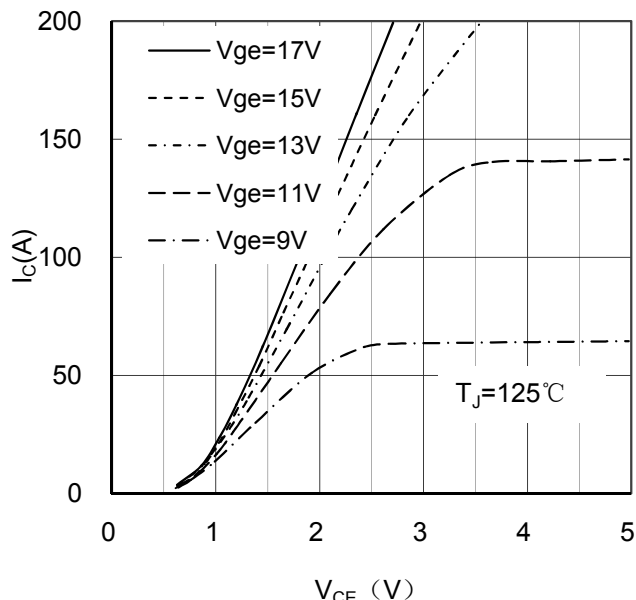

Figure 2. Typical Output Characteristics IGBT

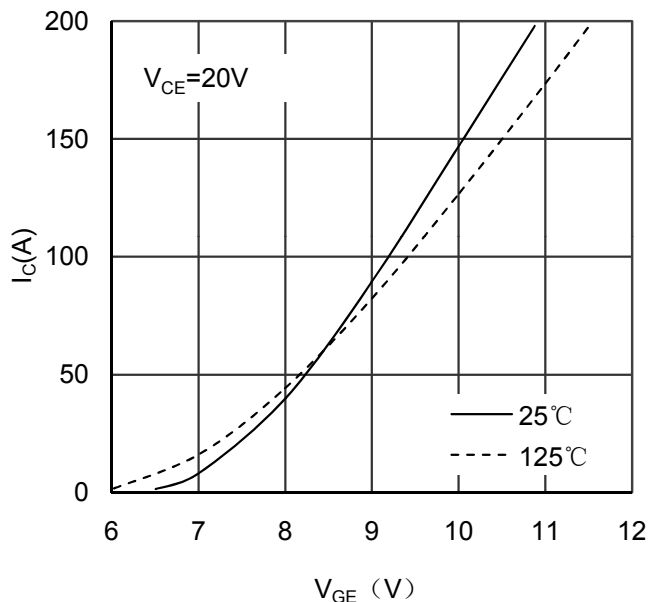

Figure 3. Typical Transfer characteristics IGBT

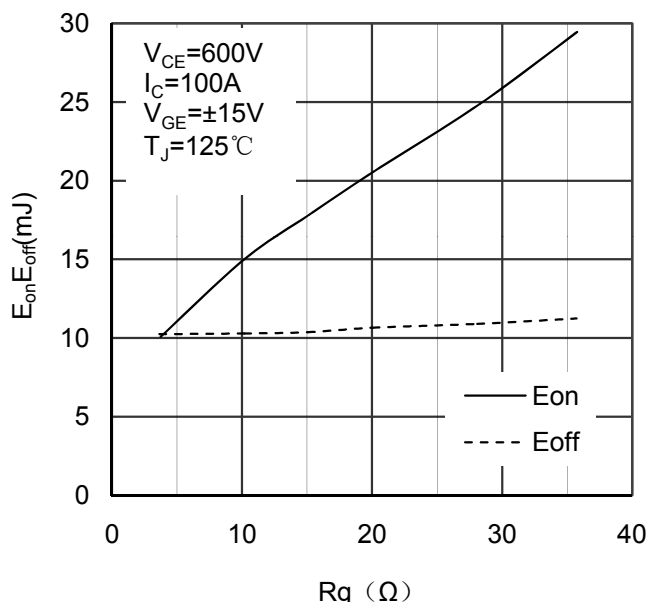

Figure 4. Switching Energy vs Gate Resistor IGBT

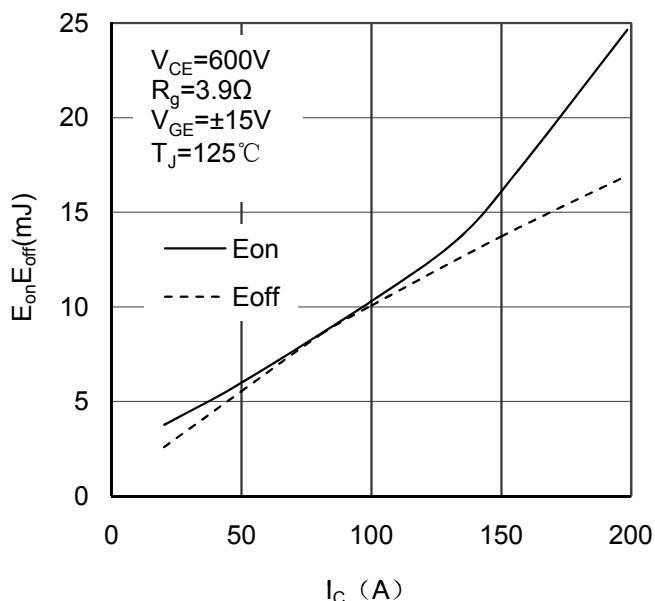

Figure 5. Switching Energy vs Collector Current IGBT

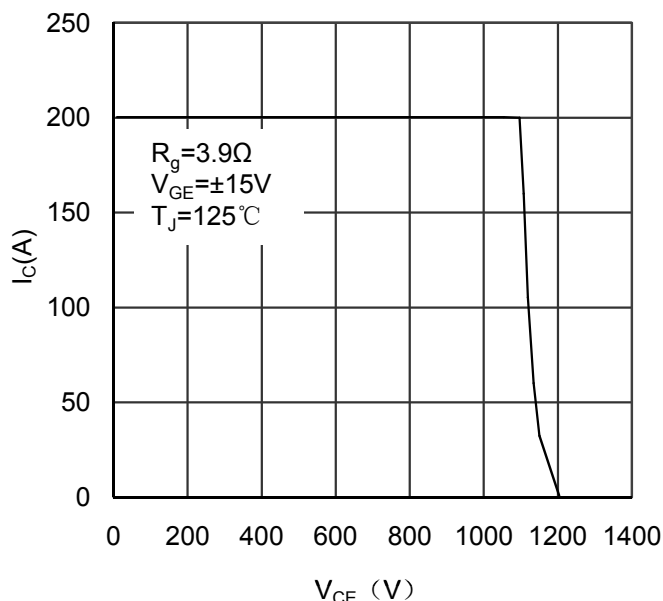

Figure 6. Reverse Biased Safe Operating Area IGBT

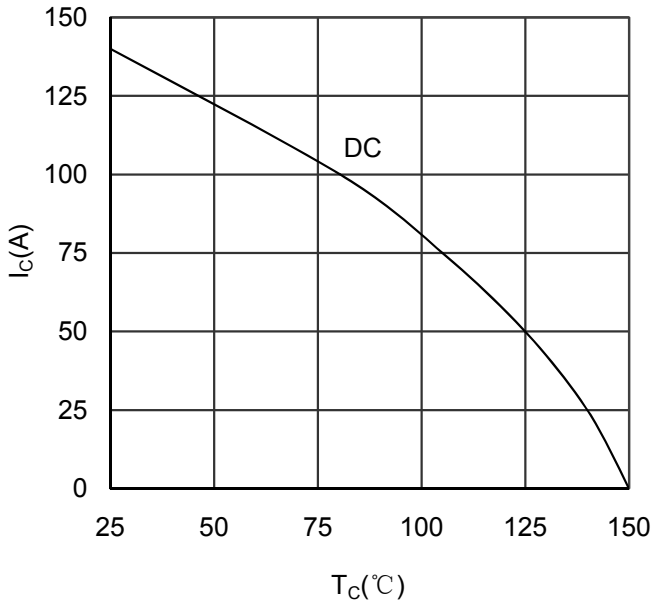

Figure 7. Collector Current vs Case temperature IGBT

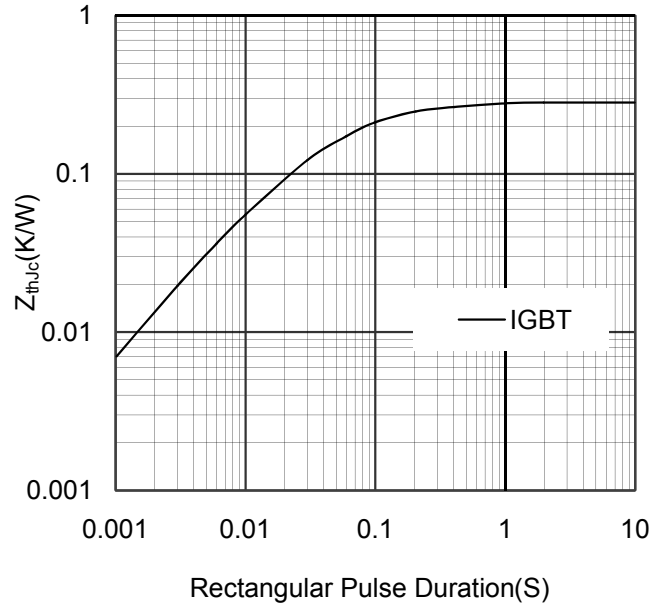
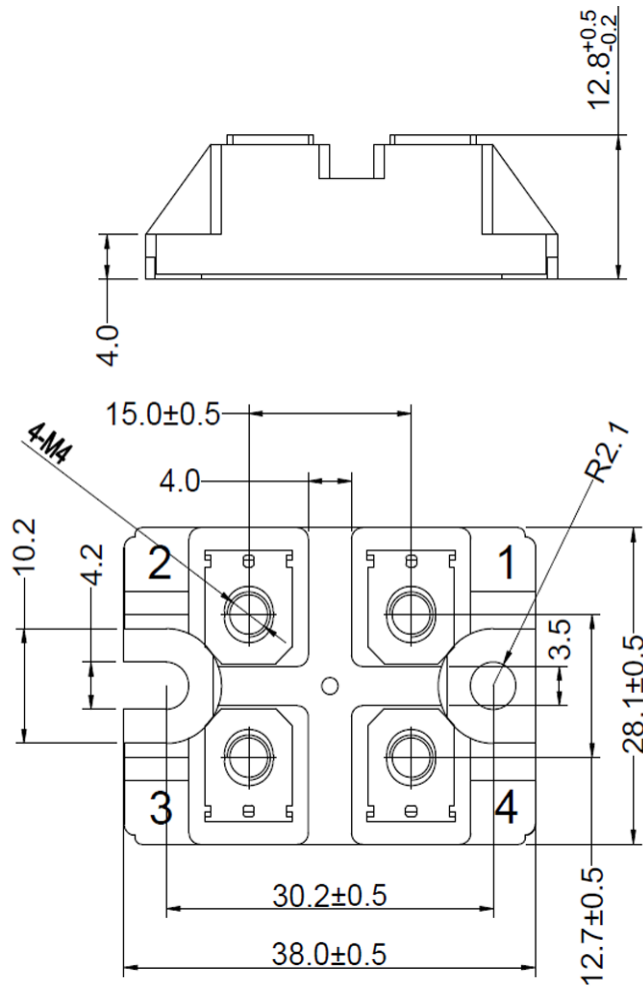

Figure 8. Transient Thermal Impedance of IGBT



Dimensions in (mm)

Figure 9. Package Outline