

PRODUCT FEATURES

- IGBT3 CHIP(1700V Trench+Field Stop technology)
- Low turn-off losses, short tail current
- $V_{CE(sat)}$ with positive temperature coefficient
- DIODE CHIP(1700V EMCON 3 technology)
- Free wheeling diodes with fast and soft reverse recovery



APPLICATIONS

- High frequency switching application
- Medical applications
- Motion/servo control
- UPS systems

IGBT-inverter

ABSOLUTE MAXIMUM RATINGS

$T_C=25^\circ\text{C}$ unless otherwise specified

Symbol	Parameter/Test Conditions		Values	Unit
V_{CES}	Collector Emitter Voltage	$T_J=25^\circ\text{C}$	1700	V
V_{GES}	Gate Emitter Voltage		± 20	
I_C	DC Collector Current	$T_C=25^\circ\text{C}$	300	A
		$T_C=95^\circ\text{C}$	200	
I_{CM}	Repetitive Peak Collector Current	$t_p=1\text{ms}$	400	
P_{tot}	Power Dissipation Per IGBT		1500	W

Diode-inverter

ABSOLUTE MAXIMUM RATINGS

$T_C=25^\circ\text{C}$ unless otherwise specified

Symbol	Parameter/Test Conditions		Values	Unit
V_{RRM}	Repetitive Reverse Voltage	$T_J=25^\circ\text{C}$	1700	V
$I_{F(AV)}$	Average Forward Current	$T_C=25^\circ\text{C}$	200	A
I_{FRM}	Repetitive Peak Forward Current	$t_p=1\text{ms}$	400	
i^2t		$T_J=125^\circ\text{C}, t=10\text{ms}, V_R=0\text{V}$	6500	A^2S

IGBT-inverter
ELECTRICAL CHARACTERISTICS
 $T_C=25^\circ\text{C}$ unless otherwise specified

Symbol	Parameter/Test Conditions		Min.	Typ.	Max.	Unit	
$V_{GE(th)}$	Gate Emitter Threshold Voltage	$V_{CE}=V_{GE}, I_C=8\text{mA}$	5.2	5.8	6.4	V	
$V_{CE(sat)}$	Collector Emitter Saturation Voltage	$I_C=200\text{A}, V_{GE}=15\text{V}, T_J=25^\circ\text{C}$		2	2.45		
		$I_C=200\text{A}, V_{GE}=15\text{V}, T_J=125^\circ\text{C}$		2.4			
I_{CES}	Collector Leakage Current	$V_{CE}=1700\text{V}, V_{GE}=0\text{V}, T_J=25^\circ\text{C}$			3	mA	
		$V_{CE}=1700\text{V}, V_{GE}=0\text{V}, T_J=125^\circ\text{C}$			20	mA	
I_{GES}	Gate Leakage Current	$V_{CE}=0\text{V}, V_{GE}=\pm 15\text{V}, T_J=25^\circ\text{C}$	-400		400	nA	
R_{gint}	Integrated Gate Resistor			3.8		Ω	
Q_g	Gate Charge	$V_{CE}=900\text{V}, I_C=200\text{A}, V_{GE}=\pm 15\text{V}$		2.4		μC	
C_{ies}	Input Capacitance	$V_{CE}=25\text{V}, V_{GE}=0\text{V}, f=1\text{MHz}$		18		nF	
C_{res}	Reverse Transfer Capacitance				600		pF
$t_{d(on)}$	Turn on Delay Time	$V_{CC}=900\text{V}, I_C=200\text{A}$ $R_G=6.8\Omega,$ $V_{GE}=\pm 15\text{V},$ Inductive Load	$T_J=25^\circ\text{C}$		280		ns
			$T_J=125^\circ\text{C}$		380		ns
t_r	Rise Time	Inductive Load	$T_J=25^\circ\text{C}$		80		ns
			$T_J=125^\circ\text{C}$		100		ns
$t_{d(off)}$	Turn off Delay Time	$V_{CC}=900\text{V}, I_C=200\text{A}$ $R_G=6.8\Omega,$ $V_{GE}=\pm 15\text{V},$ Inductive Load	$T_J=25^\circ\text{C}$		800		ns
			$T_J=125^\circ\text{C}$		1000		ns
t_f	Fall Time	Inductive Load	$T_J=25^\circ\text{C}$		120		ns
			$T_J=125^\circ\text{C}$		200		ns
E_{on}	Turn on Energy	$V_{CC}=900\text{V}, I_C=200\text{A}$ $R_G=6.8\Omega,$ $V_{GE}=\pm 15\text{V},$ Inductive Load	$T_J=25^\circ\text{C}$		58		mJ
			$T_J=125^\circ\text{C}$		78		mJ
E_{off}	Turn off Energy	Inductive Load	$T_J=25^\circ\text{C}$		43		mJ
			$T_J=125^\circ\text{C}$		63		mJ
I_{sc}	Short Circuit Current	$tp_{sc}\leq 10\mu\text{s}, V_{GE}=15\text{V}$ $T_J=125^\circ\text{C}, V_{CC}=1000\text{V}$		800		A	
R_{thJC}	Junction to Case Thermal Resistance (Per IGBT)				0.1	K/W	

Diode-inverter
ELECTRICAL CHARACTERISTICS
 $T_C=25^\circ\text{C}$ unless otherwise specified

Symbol	Parameter/Test Conditions		Min.	Typ.	Max.	Unit
V_F	Forward Voltage	$I_F=200\text{A}, V_{GE}=0\text{V}, T_J=25^\circ\text{C}$		1.8	2.2	V
		$I_F=200\text{A}, V_{GE}=0\text{V}, T_J=125^\circ\text{C}$		1.9		
t_{rr}	Reverse Recovery Time	$I_F=200\text{A}, V_R=900\text{V}$		750		ns
I_{RRM}	Max. Reverse Recovery Current	$di_F/dt=-2700\text{A}/\mu\text{s}$		230		A
Q_{RR}	Reverse Recovery Charge	$T_J=125^\circ\text{C}$		85		μC
E_{rec}	Reverse Recovery Energy				48	
R_{thJCD}	Junction to Case Thermal Resistance (Per Diode)				0.16	K/W

MODULE CHARACTERISTICS

$T_C=25^{\circ}\text{C}$ unless otherwise specified

Symbol	Parameter/Test Conditions		Values	Unit
T_{Jmax}	Max. Junction Temperature		175	°C
T_{Jop}	Operating Temperature		-40~150	
T_{stg}	Storage Temperature		-40~125	
V_{isol}	Isolation Breakdown Voltage	AC, 50Hz(R.M.S), t=1minute	4000	V
CTI	Comparative Tracking Index		> 225	
Torque	to heatsink	Recommended (M6)	3~5	Nm
	to terminal	Recommended (M6)	2.5~5	Nm
Weight			300	g

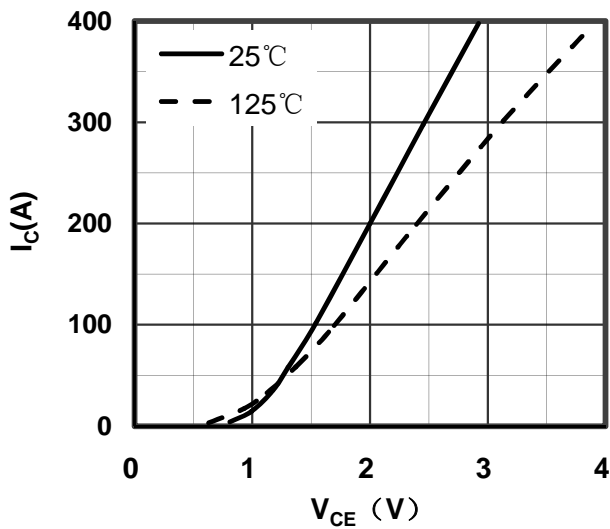

Figure 1. Typical Output Characteristics IGBT-inverter

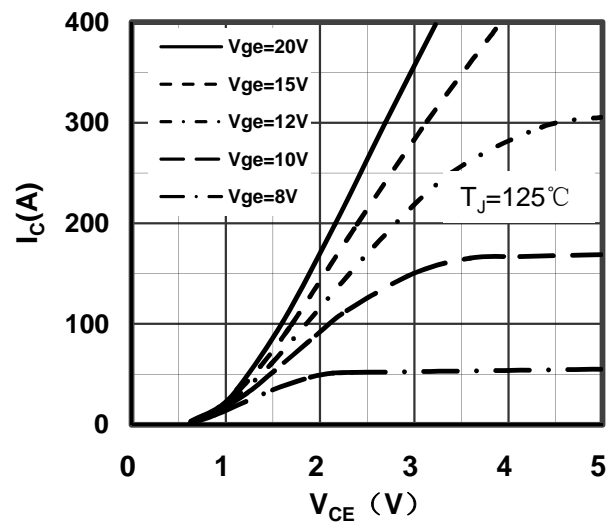

Figure 2. Typical Output Characteristics IGBT-inverter

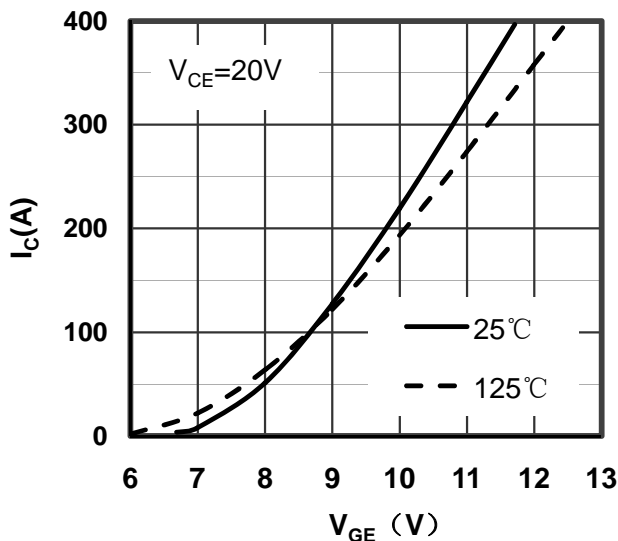

Figure 3. Typical Transfer Characteristics IGBT-inverter

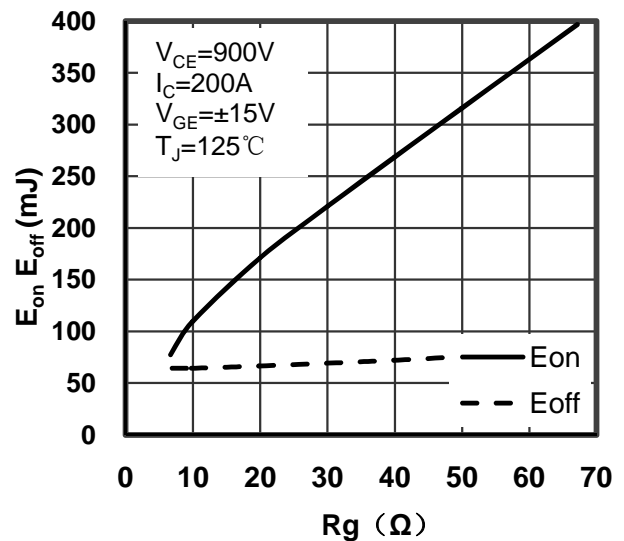

Figure 4. Switching Energy vs Gate Resistor IGBT-inverter

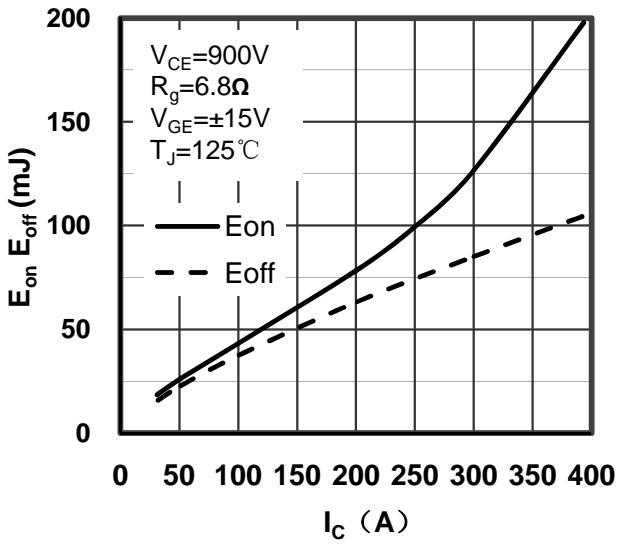

Figure 5. Switching Energy vs Collector Current IGBT-inverter

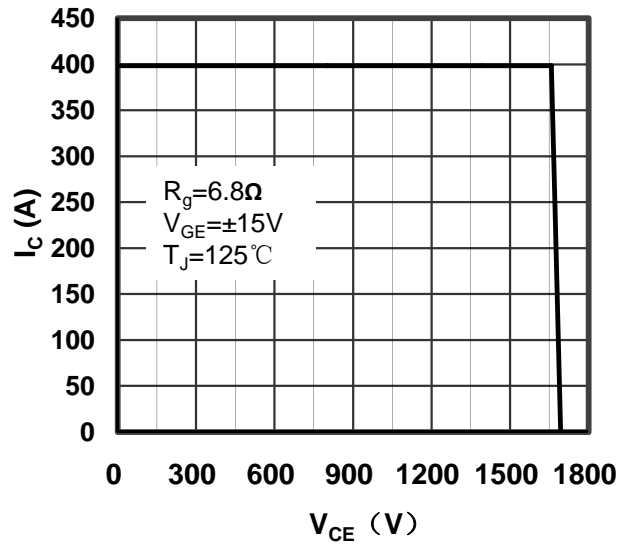

Figure 6. Reverse Biased Safe Operating Area IGBT-inverter

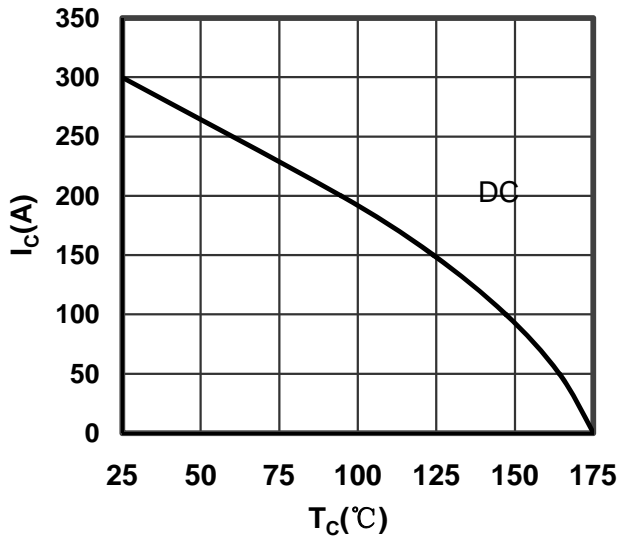

Figure 7. Collector Current vs Case temperature IGBT-inverter

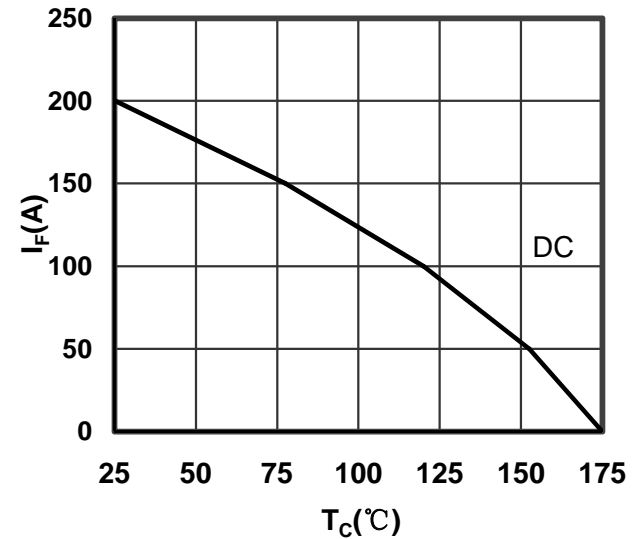

Figure 8. Forward current vs Case temperature Diode-inverter

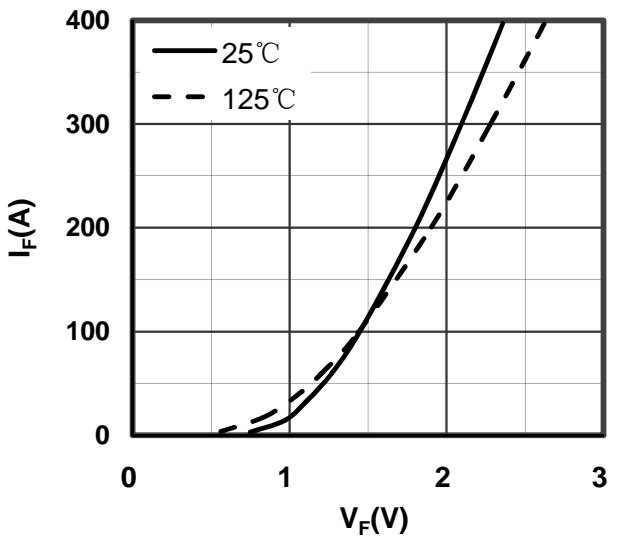

Figure 9. Diode Forward Characteristics Diode-inverter

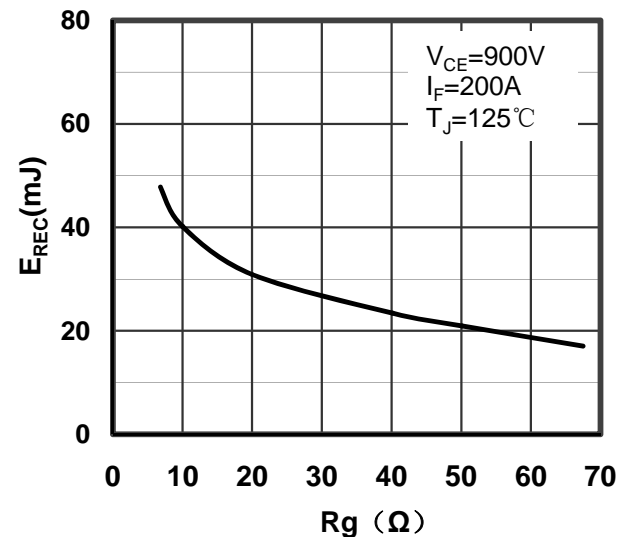

Figure 10. Switching Energy vs Gate Resistor Diode-inverter

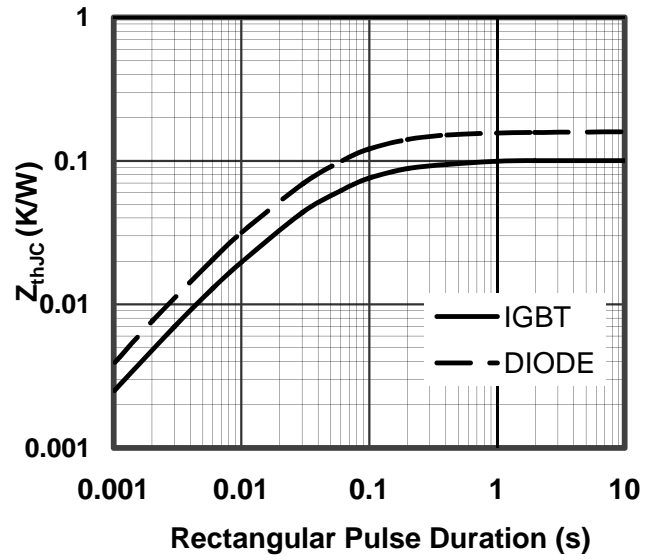
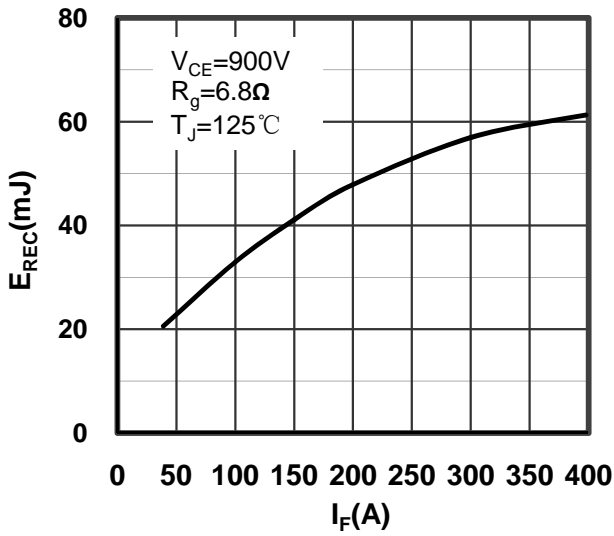

Figure 11. Switching Energy vs Forward Current Diode-inverter

Figure 12. Transient Thermal Impedance of Diode and IGBT-inverter

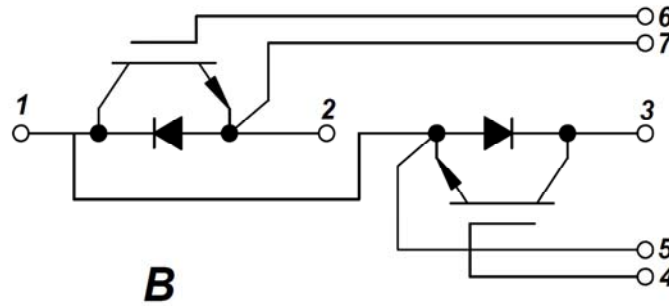
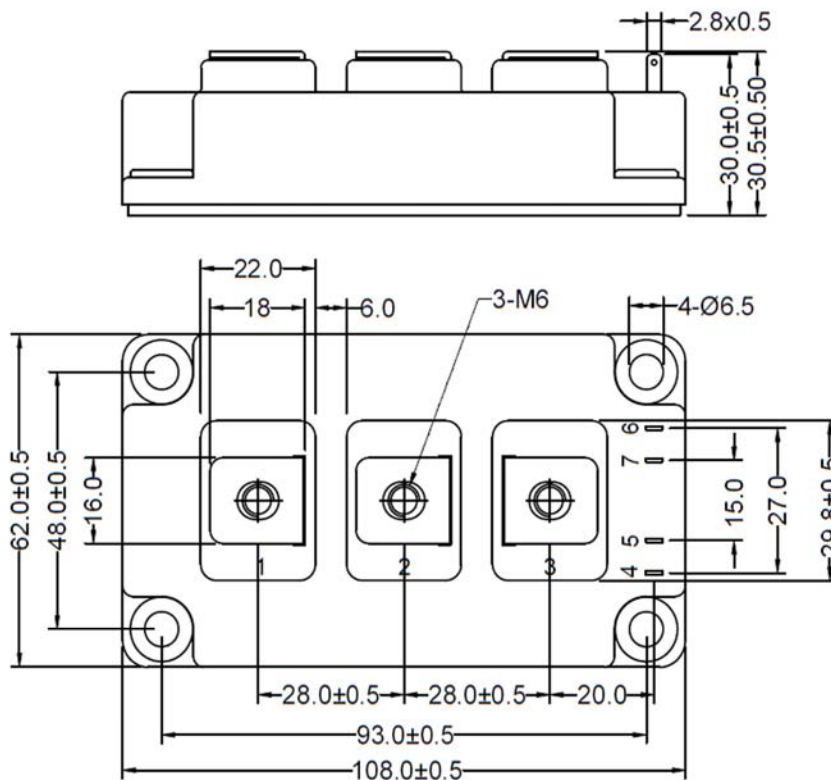

Figure 13. Circuit Diagram



Dimensions in (mm)
Figure 14. Package Outline