

## FEATURES

- High short circuit capability, self limiting short circuit current
- $V_{CE(sat)}$  with positive temperature coefficient
- Fast switching and short tail current
- Free wheeling diodes with fast and soft reverse recovery
- Low switching losses

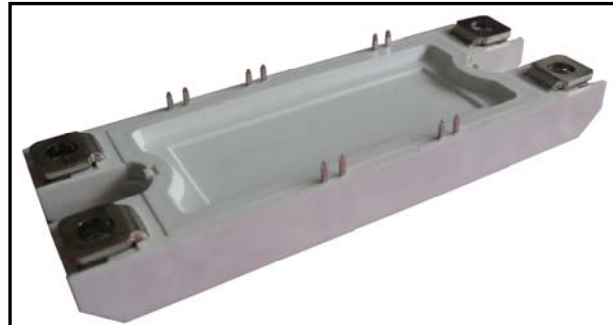

## APPLICATIONS

- High frequency switching application
- Medical applications
- Motion/servo control
- UPS systems

## ABSOLUTE MAXIMUM RATINGS

$T_C=25^{\circ}\text{C}$  unless otherwise specified

Symbol	Parameter	Test Conditions	Values	Unit
<b>IGBT</b>				
$V_{CES}$	Collector - Emitter Voltage	$T_{vj}=25^{\circ}\text{C}$	600	V
$V_{GES}$	Gate - Emitter Voltage		$\pm 20$	V
$I_c$	DC Collector Current	$T_C=25^{\circ}\text{C}$	250	A
		$T_C=75^{\circ}\text{C}$	200	A
$I_{CM}$	Repetitive Peak Collector Current	$t_p=1\text{ms}$	400	A
$P_{tot}$	Power Dissipation Per IGBT		680	W
<b>Diode</b>				
$V_{RRM}$	Repetitive Reverse Voltage	$T_{vj}=25^{\circ}\text{C}$	600	V
$I_{F(AV)}$	Average Forward Current	$T_C=25^{\circ}\text{C}$	250	A
		$T_C=75^{\circ}\text{C}$	200	A
$I_{FRM}$	Repetitive Peak Forward Current	$t_p=1\text{ms}$	400	A
$I^2t$		$T_{vj}=125^{\circ}\text{C}$ , $t=10\text{ms}$ , $V_R=0\text{V}$	2800	$\text{A}^2\text{s}$

## MMG200HB060H6EN

### ELECTRICAL AND THERMAL CHARACTERISTICS $T_C=25^\circ\text{C}$ unless otherwise specified

Symbol	Parameter	Test Conditions	Min.	Typ.	Max.	Unit
<b>IGBT</b>						
$V_{GE(th)}$	Gate - Emitter Threshold Voltage	$V_{CE}=V_{GE}, I_C=3.2\text{mA}$	4.9	5.8	6.5	V
$V_{CE(sat)}$	Collector - Emitter Saturation Voltage	$I_C=200\text{A}, V_{GE}=15\text{V}, T_{Vj}=25^\circ\text{C}$		1.45		V
		$I_C=200\text{A}, V_{GE}=15\text{V}, T_{Vj}=125^\circ\text{C}$		1.6		V
$I_{CES}$	Collector Leakage Current	$V_{CE}=600\text{V}, V_{GE}=0\text{V}, T_{Vj}=25^\circ\text{C}$			1	mA
		$V_{CE}=600\text{V}, V_{GE}=0\text{V}, T_{Vj}=125^\circ\text{C}$			5	mA
$I_{GES}$	Gate Leakage Current	$V_{CE}=0\text{V}, V_{GE} \pm 15\text{V}, T_{Vj}=125^\circ\text{C}$	-400		400	nA
$R_{Gint}$	Integrated Gate Resistor			1		$\Omega$
$Q_{ge}$	Gate Charge	$V_{CE}=300\text{V}, I_C=200\text{A}, V_{GE}=\pm 15\text{V}$		2.1		$\mu\text{C}$
$C_{ies}$	Input Capacitance	$V_{CE}=25\text{V}, V_{GE}=0\text{V}, f=1\text{MHz}$		13		nF
$C_{res}$	Reverse Transfer Capacitance			0.38		nF
$t_{d(on)}$	Turn - on Delay Time	$V_{CC}=300\text{V}, I_C=200\text{A}, T_{Vj}=25^\circ\text{C}$		110		ns
		$R_G=3.9\ \Omega, T_{Vj}=125^\circ\text{C}$		120		ns
$t_r$	Rise Time	$V_{GE}=\pm 15\text{V}, T_{Vj}=25^\circ\text{C}$		50		ns
		Inductive Load $T_{Vj}=125^\circ\text{C}$		60		ns
$t_{d(off)}$	Turn - off Delay Time	$V_{CC}=300\text{V}, I_C=200\text{A}, T_{Vj}=25^\circ\text{C}$		490		ns
		$R_G=3.9\ \Omega, T_{Vj}=125^\circ\text{C}$		520		ns
$t_f$	Fall Time	$V_{GE}=\pm 15\text{V}, T_{Vj}=25^\circ\text{C}$		60		ns
		Inductive Load $T_{Vj}=125^\circ\text{C}$		70		ns
$E_{on}$	Turn - on Energy	$V_{CC}=300\text{V}, I_C=200\text{A}, T_{Vj}=25^\circ\text{C}$		2.5		mJ
		$R_G=3.9\ \Omega, T_{Vj}=125^\circ\text{C}$		3.5		mJ
$E_{off}$	Turn - off Energy	$V_{GE}=\pm 15\text{V}, T_{Vj}=25^\circ\text{C}$		5.5		mJ
		Inductive Load $T_{Vj}=125^\circ\text{C}$		8.0		mJ
$I_{sc}$	Short Circuit Current	$t_{psc} \leq 6\ \mu\text{s}, V_{GE}=15\text{V}$ $T_{Vj}=125^\circ\text{C}, V_{CC}=360\text{V}$		950		A
$R_{thJC}$	Junction-to-Case Thermal Resistance ( Per IGBT )				0.22	K/W
<b>Diode</b>						
$V_F$	Forward Voltage	$I_F=200\text{A}, V_{GE}=0\text{V}, T_{Vj}=25^\circ\text{C}$		1.55		V
		$I_F=200\text{A}, V_{GE}=0\text{V}, T_{Vj}=125^\circ\text{C}$		1.50		V
$I_{RRM}$	Max. Reverse Recovery Current	$I_F=200\text{A}, V_R=300\text{V}$		170		A
$Q_{rr}$	Reverse Recovery Charge	$di_F/dt=-3500\text{A}/\mu\text{s}$		16.0		$\mu\text{C}$
$E_{rec}$	Reverse Recovery Energy	$T_{Vj}=125^\circ\text{C}$		4.0		mJ
$R_{thJCD}$	Junction-to-Case Thermal Resistance ( Per Diode )				0.42	K/W

**NTC SECTOR**

**CHARACTERISTIC VALUES**

*T<sub>c</sub>=25°C unless otherwise specified*

Symbol	Parameter	Test Conditions	Min.	Typ.	Max.	Unit
R <sub>25</sub>	Resistance	T <sub>c</sub> =25°C		5		KΩ
B <sub>25/50</sub>				3375		K

**MODULE CHARACTERISTICS**

*T<sub>c</sub>=25°C unless otherwise specified*

Symbol	Parameter	Test Conditions	Min.	Typ.	Max.	Unit
T <sub>vj max</sub>	Max. Junction Temperature				175	°C
T <sub>vj op</sub>	Operating Temperature		-40		150	°C
T <sub>stg</sub>	Storage Temperature		-40		125	°C
V <sub>isol</sub>	Insulation Test Voltage	AC, t=1min		3000		V
CTI	Comparative Tracking Index		350			
Torque	Module-to-Sink	Recommended (M6)	3		5	N · m
Torque	Module Electrodes	Recommended (M6)	2.5		5	N · m
Weight				200		g

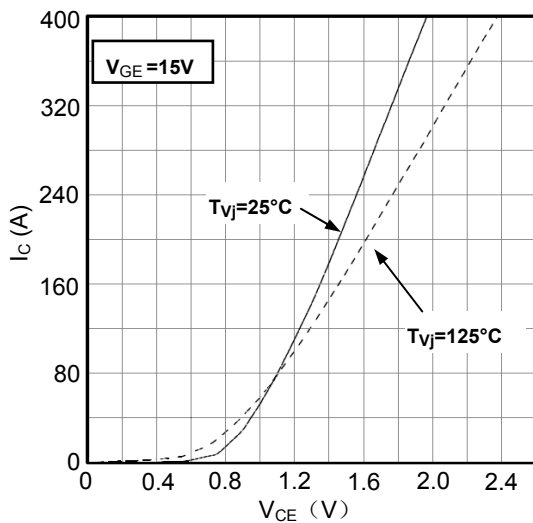

Figure1. Typical Output characteristics IGBT-inverter

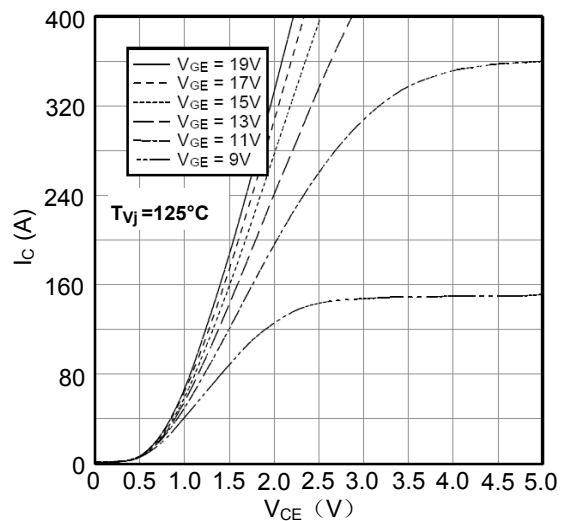

Figure2. Typical Output characteristics IGBT-inverter

# MMG200HB060H6EN

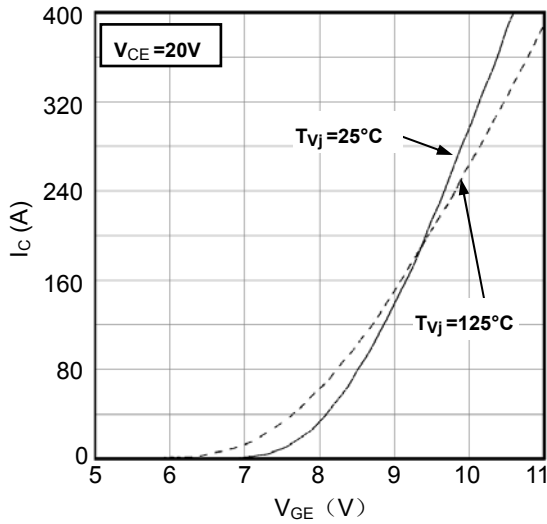

Figure3. Typical Transfer characteristics IGBT-inverter

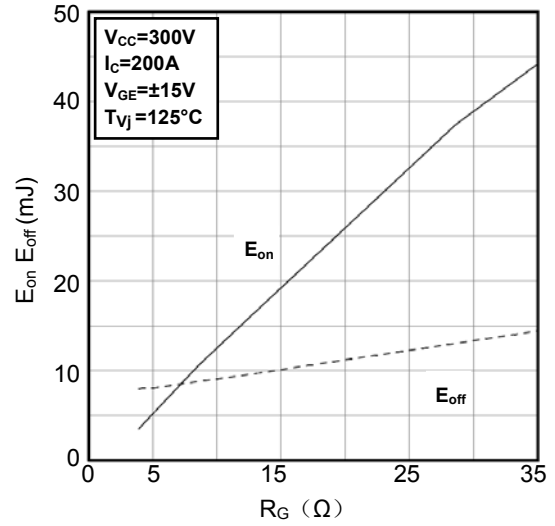

Figure4. Switching Energy vs. Gate Resistor IGBT-inverter

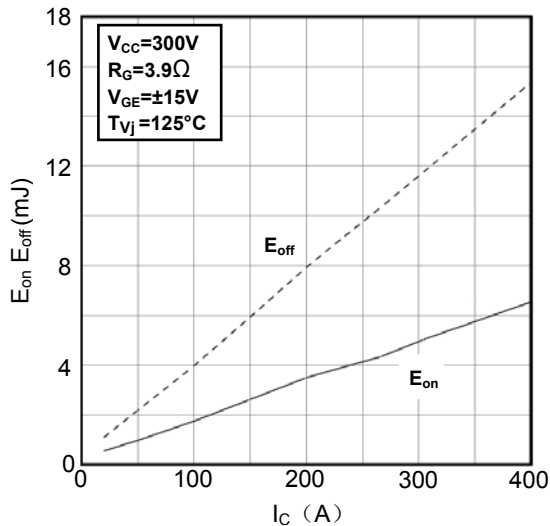

Figure5. Switching Energy vs. Collector Current IGBT-inverter

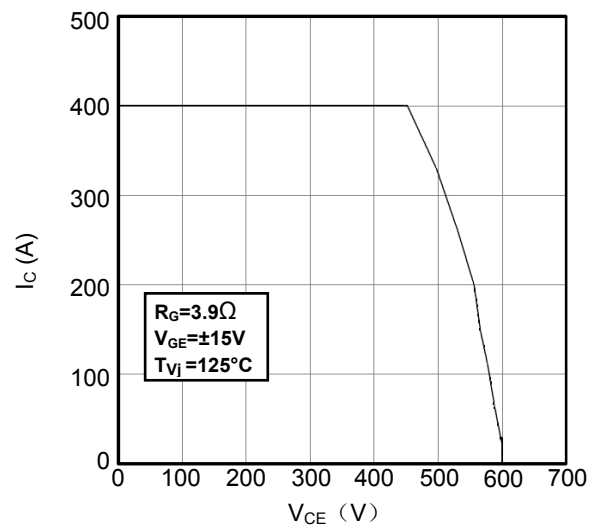

Figure6. Reverse Biased Safe Operating Area IGBT-inverter

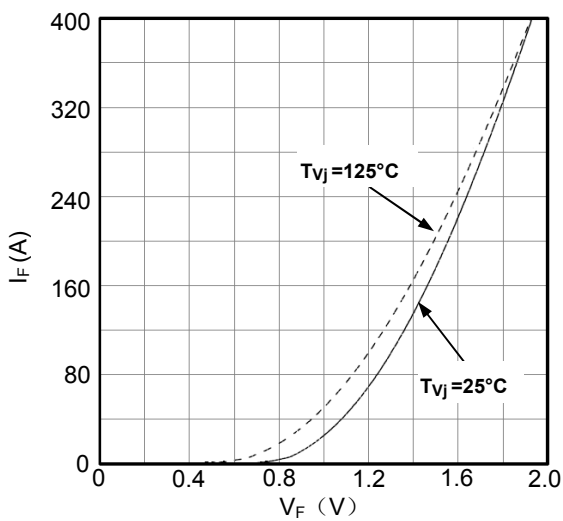

Figure7. Diode Forward Characteristics Diode -inverter

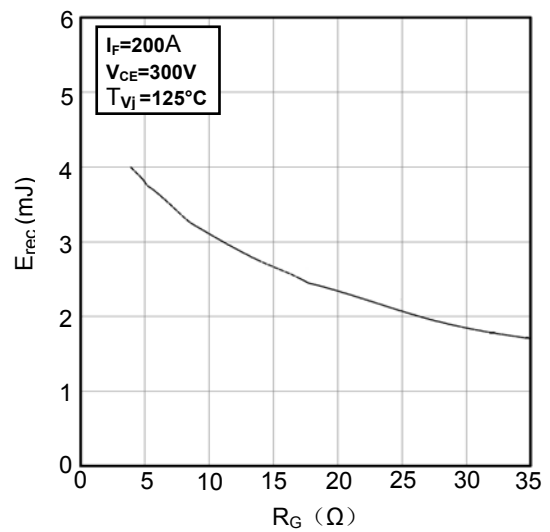

Figure8. Switching Energy vs. Gate Resistor Diode -inverter

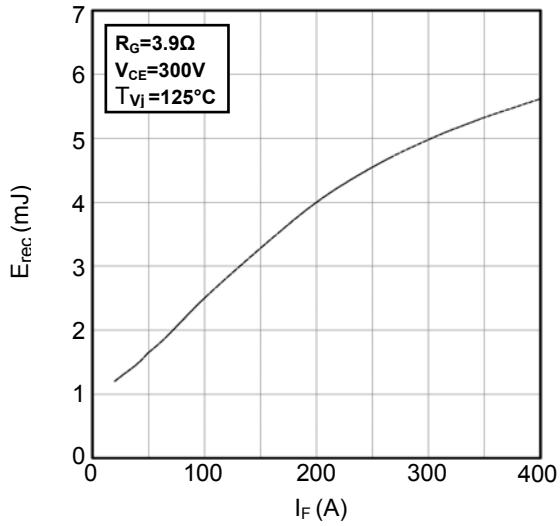

Figure9. Switching Energy vs. Forward Current  
Diode -inverter

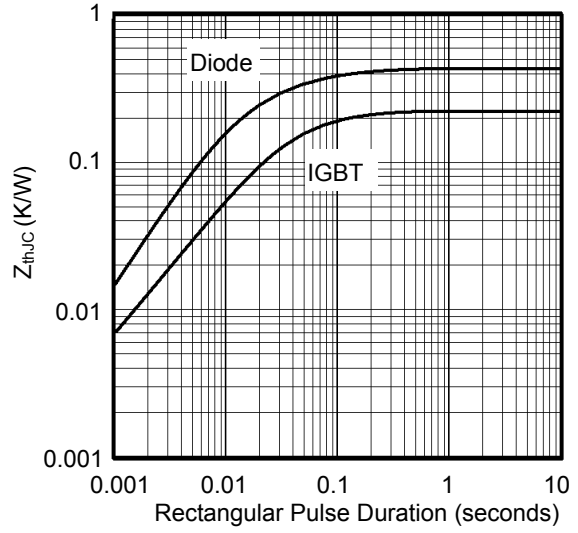

Figure10. Transient Thermal Impedance of  
Diode and IGBT-inverter

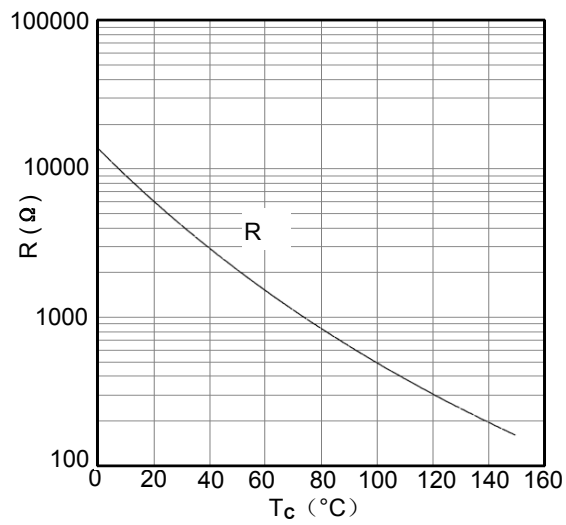

Figure11. NTC Characteristics

MMG200HB060H6EN

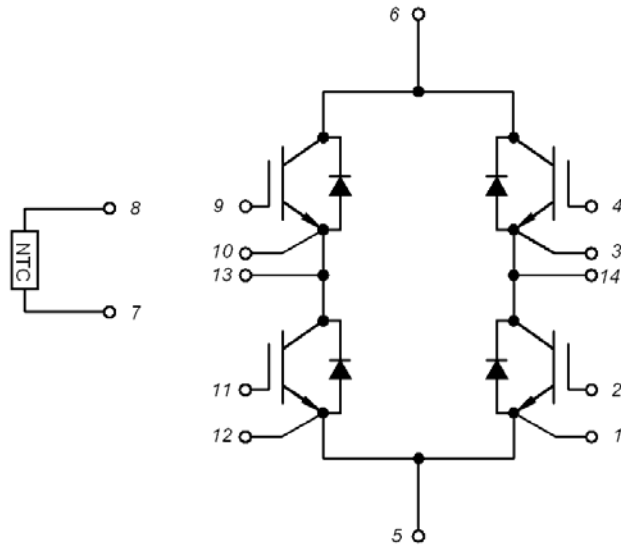
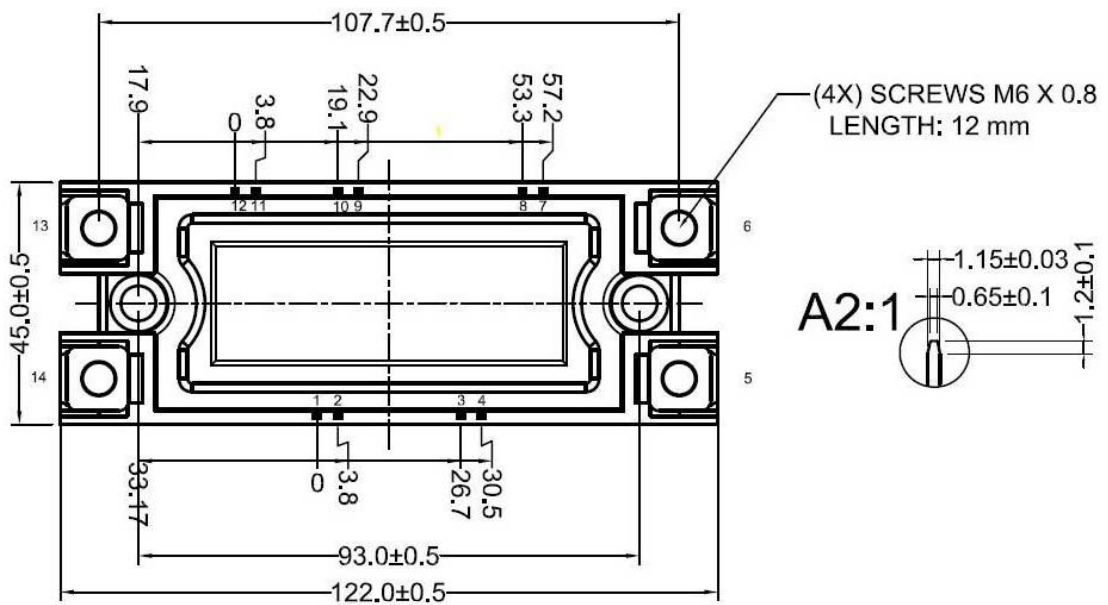
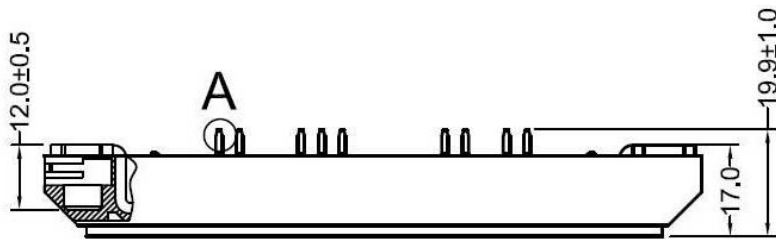

Figure12. Circuit Diagram



Dimensions (mm)  
Figure13. Package Outline