

## PRODUCT FEATURES

- High level of integration
- IGBT<sup>3</sup> CHIP(Trench+Field Stop technology)
- Low saturation voltage and positive temperature coefficient
- Fast switching and short tail current
- Free wheeling diodes with fast and soft reverse recovery
- Industry standard package with insulated copper base plate and soldering pins for PCB mounting
- Temperature sense included

## APPLICATIONS

- AC motor control
- Motion/servo control
- Inverter and power supplies



Rectifier+Brake+Inverter

### IGBT-inverter

ABSOLUTE MAXIMUM RATINGS( $T_C=25^{\circ}\text{C}$  unless otherwise specified)

Symbol	Parameter/Test Conditions	Values	Unit
$V_{CES}$	Collector Emitter Voltage	$T_J=25^{\circ}\text{C}$	1200
$V_{GES}$	Gate Emitter Voltage		$\pm 20$
$I_C$	DC Collector Current	$T_C=25^{\circ}\text{C}, T_{Jmax}=150^{\circ}\text{C}$	55
		$T_C=80^{\circ}\text{C}, T_{Jmax}=150^{\circ}\text{C}$	40
$I_{CM}$	Repetitive Peak Collector Current	$t_p=1\text{ms}$	80
$P_{tot}$	Power Dissipation Per IGBT	$T_C=25^{\circ}\text{C}, T_{Jmax}=150^{\circ}\text{C}$	195

### Diode-inverter

ABSOLUTE MAXIMUM RATINGS ( $T_C=25^{\circ}\text{C}$  unless otherwise specified)

Symbol	Parameter/Test Conditions	Values	Unit
$V_{RRM}$	Repetitive Reverse Voltage	$T_J=25^{\circ}\text{C}$	1200
$I_{F(AV)}$	Average Forward Current		40
$I_{FRM}$	Repetitive Peak Forward Current	$t_p=1\text{ms}$	80
$I^2t$		$T_J=125^{\circ}\text{C}, t=10\text{ms}, V_R=0\text{V}$	300

MacMic Science & Technology Co., Ltd.

Add: #18, Hua Shan Zhong Lu, New District, Changzhou City, Jiangsu Province, P. R. of China

Tel.: +86-519-85163708 Fax: +86-519-85162291 Post Code: 213022 Website: www.macmicst.com

## MMG40W120XB6TN

### IGBT-inverter

#### ELECTRICAL CHARACTERISTICS ( $T_C=25^\circ\text{C}$ unless otherwise specified)

Symbol	Parameter/Test Conditions		Min.	Typ.	Max.	Unit
$V_{GE(th)}$	Gate Emitter Threshold Voltage	$V_{CE}=V_{GE}, I_C=1.5\text{mA}$	5.0	5.8	6.5	V
$V_{CE(sat)}$	Collector Emitter Saturation Voltage	$I_C=40\text{A}, V_{GE}=15\text{V}, T_J=25^\circ\text{C}$		1.8	2.3	
		$I_C=40\text{A}, V_{GE}=15\text{V}, T_J=125^\circ\text{C}$		2.05		
$I_{CES}$	Collector Leakage Current	$V_{CE}=1200\text{V}, V_{GE}=0\text{V}, T_J=25^\circ\text{C}$			100	$\mu\text{A}$
		$V_{CE}=1200\text{V}, V_{GE}=0\text{V}, T_J=125^\circ\text{C}$			10	$\text{mA}$
$I_{GES}$	Gate Leakage Current	$V_{CE}=0\text{V}, V_{GE}=\pm 15\text{V}, T_J=25^\circ\text{C}$	-400		400	$\text{nA}$
$R_{gint}$	Integrated Gate Resistor			6		$\Omega$
$Q_g$	Gate Charge	$V_{CE}=600\text{V}, I_C=40\text{A}, V_{GE}=\pm 15\text{V}$		0.33		$\mu\text{C}$
$C_{ies}$	Input Capacitance	$V_{CE}=25\text{V}, V_{GE}=0\text{V}, f=1\text{MHz}$		2.5		$\text{nF}$
$C_{res}$	Reverse Transfer Capacitance			0.11		$\text{nF}$
$t_{d(on)}$	Turn on Delay Time	$V_{CC}=600\text{V}, I_C=40\text{A}$ $R_G=27\Omega,$ $V_{GE}=\pm 15\text{V},$ Inductive Load	$T_J=25^\circ\text{C}$		90	$\text{ns}$
			$T_J=125^\circ\text{C}$		90	$\text{ns}$
$t_r$	Rise Time	$V_{GE}=\pm 15\text{V},$ Inductive Load	$T_J=25^\circ\text{C}$		30	$\text{ns}$
			$T_J=125^\circ\text{C}$		50	$\text{ns}$
$t_{d(off)}$	Turn off Delay Time	$V_{CC}=600\text{V}, I_C=40\text{A}$ $R_G=27\Omega,$ $V_{GE}=\pm 15\text{V},$ Inductive Load	$T_J=25^\circ\text{C}$		420	$\text{ns}$
			$T_J=125^\circ\text{C}$		520	$\text{ns}$
$t_f$	Fall Time	$V_{GE}=\pm 15\text{V},$ Inductive Load	$T_J=25^\circ\text{C}$		70	$\text{ns}$
			$T_J=125^\circ\text{C}$		90	$\text{ns}$
$E_{on}$	Turn on Energy	$V_{CC}=600\text{V}, I_C=40\text{A}$ $R_G=27\Omega,$ $V_{GE}=\pm 15\text{V},$ Inductive Load	$T_J=25^\circ\text{C}$		4.1	$\text{mJ}$
			$T_J=125^\circ\text{C}$		5.8	$\text{mJ}$
$E_{off}$	Turn off Energy	$V_{GE}=\pm 15\text{V},$ Inductive Load	$T_J=25^\circ\text{C}$		3.6	$\text{mJ}$
			$T_J=125^\circ\text{C}$		4.2	$\text{mJ}$
$I_{SC}$	Short Circuit Current	$t_{psc}\leq 10\mu\text{s}, V_{GE}=15\text{V}$ $T_J=125^\circ\text{C}, V_{CC}=900\text{V}$		160		A
$R_{thJC}$	Junction to Case Thermal Resistance ( Per IGBT )				0.64	$\text{K/W}$

### Diode-inverter

#### ELECTRICAL CHARACTERISTICS ( $T_C=25^\circ\text{C}$ unless otherwise specified)

Symbol	Parameter/Test Conditions		Min.	Typ.	Max.	Unit
$V_F$	Forward Voltage	$I_F=40\text{A}, V_{GE}=0\text{V}, T_J=25^\circ\text{C}$		1.75	2.3	V
		$I_F=40\text{A}, V_{GE}=0\text{V}, T_J=125^\circ\text{C}$		1.75		
$t_{rr}$	Reverse Recovery Time	$I_F=40\text{A}, V_R=600\text{V}$ $dI_F/dt=-1000\text{A}/\mu\text{s}$ $T_J=125^\circ\text{C}$		360		$\text{ns}$
$I_{RRM}$	Max. Reverse Recovery Current			46		A
$Q_{RR}$	Reverse Recovery Charge			8.4		$\mu\text{C}$
$E_{rec}$	Reverse Recovery Energy			3.1		$\text{mJ}$
$R_{thJCD}$	Junction to Case Thermal Resistance ( Per Diode )				1.0	$\text{K/W}$

## MMG40W120XB6TN

### Diode-RECTIFIER

ABSOLUTE MAXIMUM RATINGS ( $T_C=25^\circ\text{C}$  unless otherwise specified)

Symbol	Parameter/Test Conditions		Values	Unit
$V_{RRM}$	Repetitive Reverse Voltage	$T_J=25^\circ\text{C}$	1600	V
$I_{F(AV)}$	Average Forward Current Per Diode	$T_C=80^\circ\text{C}$	50	A
$I_{FRMS}$	R.M.S. Forward Current Per Diode		75	
$I_{RMS}$	R.M.S. Current at rectifier output		80	
$I_{FSM}$	Non Repetitive Surge Forward Current	$T_J=45^\circ\text{C}$ , $t=10\text{ms}$ , 50Hz	480	
		$T_J=45^\circ\text{C}$ , $t=8.3\text{ms}$ , 60Hz	527	
$I^2t$		$T_J=45^\circ\text{C}$ , $t=10\text{ms}$ , 50Hz	1152	A <sup>2</sup> S
		$T_J=45^\circ\text{C}$ , $t=8.3\text{ms}$ , 60Hz	1152	

### Diode-RECTIFIER

ELECTRICAL CHARACTERISTICS ( $T_C=25^\circ\text{C}$  unless otherwise specified)

Symbol	Parameter/Test Conditions		Min.	Typ.	Max.	Unit
$V_F$	Forward Voltage	$I_F=40\text{A}$ , $T_J=25^\circ\text{C}$		1.06	1.2	V
		$I_F=40\text{A}$ , $T_J=150^\circ\text{C}$		1.00		V
$I_R$	Reverse Leakage Current	$V_R=1600\text{V}$ , $T_J=25^\circ\text{C}$			50	$\mu\text{A}$
		$V_R=1600\text{V}$ , $T_J=150^\circ\text{C}$			1	mA
$R_{thJCD}$	Junction to Case Thermal Resistance ( Per Diode )				0.8	K/W

### IGBT-Brake chopper

ABSOLUTE MAXIMUM RATINGS ( $T_C=25^\circ\text{C}$  unless otherwise specified)

Symbol	Parameter/Test Conditions		Values	Unit
$V_{CES}$	Collector Emitter Voltage	$T_J=25^\circ\text{C}$	1200	V
$V_{GES}$	Gate Emitter Voltage		$\pm 20$	
$I_C$	DC Collector Current	$T_C=25^\circ\text{C}$ , $T_{Jmax}=150^\circ\text{C}$	25	A
		$T_C=80^\circ\text{C}$ , $T_{Jmax}=150^\circ\text{C}$	15	
$I_{CM}$	Repetitive Peak Collector Current	$t_p=1\text{ms}$	30	
$P_{tot}$	Power Dissipation Per IGBT	$T_C=25^\circ\text{C}$ , $T_{Jmax}=150^\circ\text{C}$	105	W

### Diode-Brake chopper

ABSOLUTE MAXIMUM RATINGS ( $T_C=25^\circ\text{C}$  unless otherwise specified)

Symbol	Parameter/Test Conditions		Values	Unit
$V_{RRM}$	Repetitive Reverse Voltage	$T_J=25^\circ\text{C}$	1200	V
$I_{F(AV)}$	Average Forward Current		15	A
$I_{FRM}$	Repetitive Peak Forward Current	$t_p=1\text{ms}$	30	
$I^2t$		$T_J=125^\circ\text{C}$ , $t=10\text{ms}$ , $V_R=0\text{V}$	60	A <sup>2</sup> S

## MMG40W120XB6TN

IGBT-Brake chopper

ELECTRICAL CHARACTERISTICS ( $T_C=25^\circ\text{C}$  unless otherwise specified)

Symbol	Parameter/Test Conditions		Min.	Typ.	Max.	Unit
$V_{GE(th)}$	Gate Emitter Threshold Voltage	$V_{CE}=V_{GE}, I_C=0.6\text{mA}$	5.2	5.8	6.4	V
$V_{CE(sat)}$	Collector - Emitter Saturation Voltage	$I_C=15\text{A}, V_{GE}=15\text{V}, T_J=25^\circ\text{C}$		1.7	2.15	
		$I_C=15\text{A}, V_{GE}=15\text{V}, T_J=125^\circ\text{C}$		1.9		
$I_{CES}$	Collector Leakage Current	$V_{CE}=1200\text{V}, V_{GE}=0\text{V}, T_J=25^\circ\text{C}$			10	$\mu\text{A}$
		$V_{CE}=1200\text{V}, V_{GE}=0\text{V}, T_J=125^\circ\text{C}$			10	$\text{mA}$
$I_{GES}$	Gate Leakage Current	$V_{CE}=0\text{V}, V_{GE}=\pm 15\text{V}, T_J=25^\circ\text{C}$	-400		400	$\text{nA}$
$R_{gint}$	Integrated Gate Resistor			0		$\Omega$
$Q_g$	Gate Charge	$V_{CE}=600\text{V}, I_C=15\text{A}, V_{GE}=\pm 15\text{V}$		0.15		$\mu\text{C}$
$C_{ies}$	Input Capacitance	$V_{CE}=25\text{V}, V_{GE}=0\text{V}, f=1\text{MHz}$		1.1		$\text{nF}$
$C_{res}$	Reverse Transfer Capacitance			0.04		$\text{nF}$
$t_{d(on)}$	Turn on Delay Time	$V_{CC}=600\text{V}, I_C=15\text{A}, R_G=75\Omega, V_{GE}=\pm 15\text{V},$ Inductive Load	$T_J=25^\circ\text{C}$		90	$\text{ns}$
			$T_J=125^\circ\text{C}$		90	$\text{ns}$
$t_r$	Rise Time	$V_{GE}=\pm 15\text{V},$ Inductive Load	$T_J=25^\circ\text{C}$		30	$\text{ns}$
			$T_J=125^\circ\text{C}$		50	$\text{ns}$
$t_{d(off)}$	Turn off Delay Time	$V_{CC}=600\text{V}, I_C=15\text{A}, R_G=75\Omega, V_{GE}=\pm 15\text{V},$ Inductive Load	$T_J=25^\circ\text{C}$		420	$\text{ns}$
			$T_J=125^\circ\text{C}$		520	$\text{ns}$
$t_f$	Fall Time	$V_{GE}=\pm 15\text{V},$ Inductive Load	$T_J=25^\circ\text{C}$		70	$\text{ns}$
			$T_J=125^\circ\text{C}$		90	$\text{ns}$
$E_{on}$	Turn on Energy	$V_{CC}=600\text{V}, I_C=15\text{A}, R_G=75\Omega, V_{GE}=\pm 15\text{V},$ Inductive Load	$T_J=25^\circ\text{C}$		1.5	$\text{mJ}$
			$T_J=125^\circ\text{C}$		2.1	$\text{mJ}$
$E_{off}$	Turn off Energy	$V_{GE}=\pm 15\text{V},$ Inductive Load	$T_J=25^\circ\text{C}$		1.1	$\text{mJ}$
			$T_J=125^\circ\text{C}$		1.3	$\text{mJ}$
$I_{SC}$	Short Circuit Current	$t_{psc}\leq 10\mu\text{s}, V_{GE}=15\text{V}$ $T_J=125^\circ\text{C}, V_{CC}=900\text{V}$		60		A
$R_{thJC}$	Junction to Case Thermal Resistance (Per IGBT)				1.2	$\text{K/W}$

Diode-Brake chopper

ELECTRICAL CHARACTERISTICS ( $T_C=25^\circ\text{C}$  unless otherwise specified)

Symbol	Parameter/Test Conditions		Min.	Typ.	Max.	Unit
$V_F$	Forward Voltage	$I_F=15\text{A}, V_{GE}=0\text{V}, T_J=25^\circ\text{C}$		1.65	2.15	V
		$I_F=15\text{A}, V_{GE}=0\text{V}, T_J=125^\circ\text{C}$		1.65		
$t_{rr}$	Reverse Recovery Time	$I_F=15\text{A}, V_R=600\text{V}$		250		$\text{ns}$
$I_{RRM}$	Max. Reverse Recovery Current	$di_f/dt=-400\text{A}/\mu\text{s}$ $T_J=125^\circ\text{C}$		16		A
$E_{rec}$	Reverse Recovery Energy			1.1		$\text{mJ}$
$R_{thJCD}$	Junction to Case Thermal Resistance (Per Diode)				1.5	$\text{K/W}$

# MMG40W120XB6TN

## NTC CHARACTERISTICS ( $T_C=25^\circ\text{C}$ unless otherwise specified)

Symbol	Parameter/Test Conditions	Min.	Typ.	Max.	Unit
$R_{25}$	Resistance $T_C=25^\circ\text{C}$		5		$\text{k}\Omega$
$B_{25/50}$	$R_2 = R_{25} \exp [B_{25/50}(1/T_2 - 1/(298.15 \text{ K}))]$		3375		K

## MODULE CHARACTERISTICS ( $T_C=25^\circ\text{C}$ unless otherwise specified)

Symbol	Parameter/Test Conditions	Values	Unit	
$T_{Jmax}$	Max. Junction Temperature	150	$^\circ\text{C}$	
$T_{Jop}$	Operating Temperature	-40~125		
$T_{stg}$	Storage Temperature	-40~125		
$V_{isol}$	Isolation Breakdown Voltage	AC, 50Hz(R.M.S), t=1minute	3000	V
CTI	Comparative Tracking Index		>200	
Md	Mounting Torque	Recommended (M5)	2.5~5	Nm
Weight			300	g

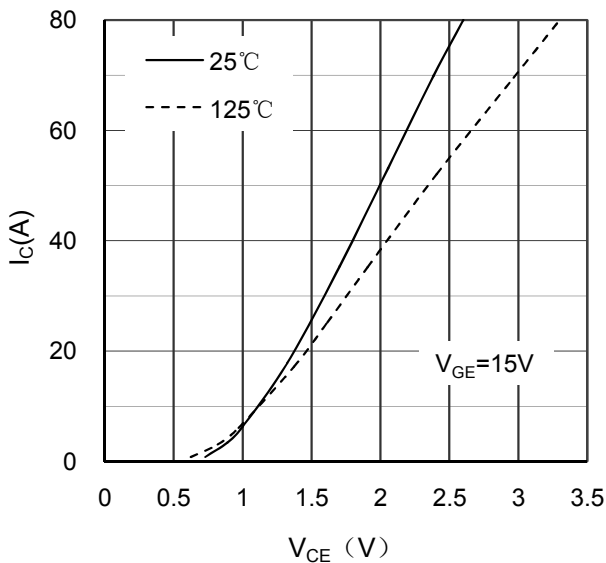

Figure 1. Typical Output Characteristics IGBT-inverter

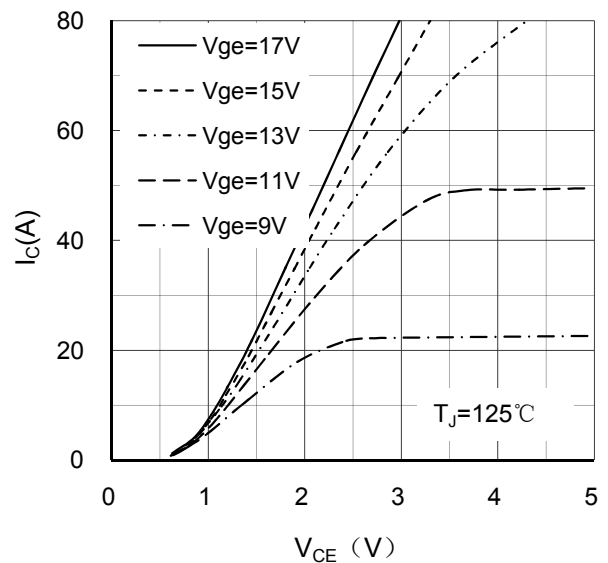

Figure 2. Typical Output Characteristics IGBT-inverter

# MMG40W120XB6TN

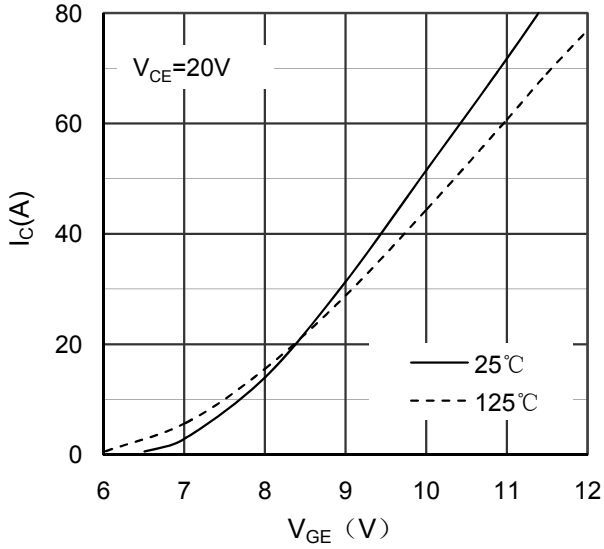

Figure 3. Typical Transfer characteristics IGBT-inverter

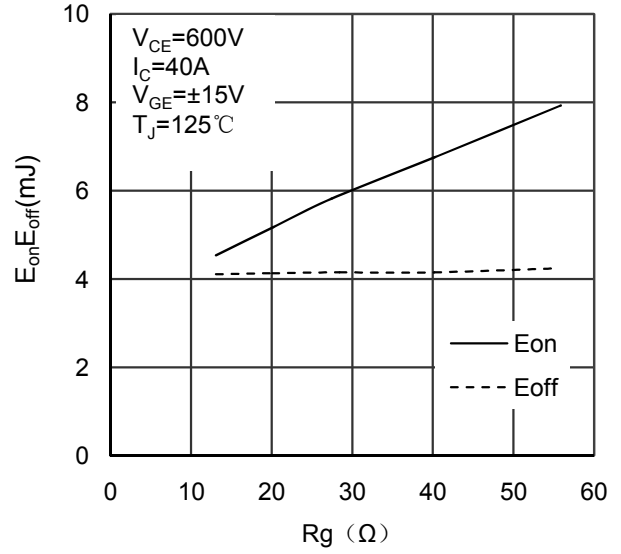

Figure 4. Switching Energy vs Gate Resistor IGBT-inverter

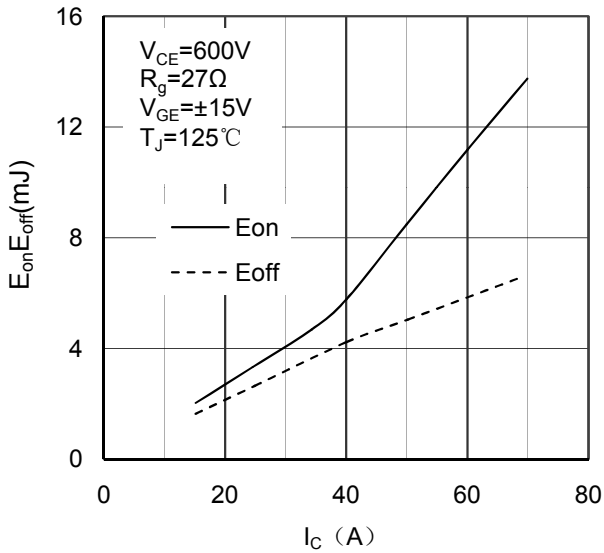

Figure 5. Switching Energy vs Collector Current IGBT-inverter

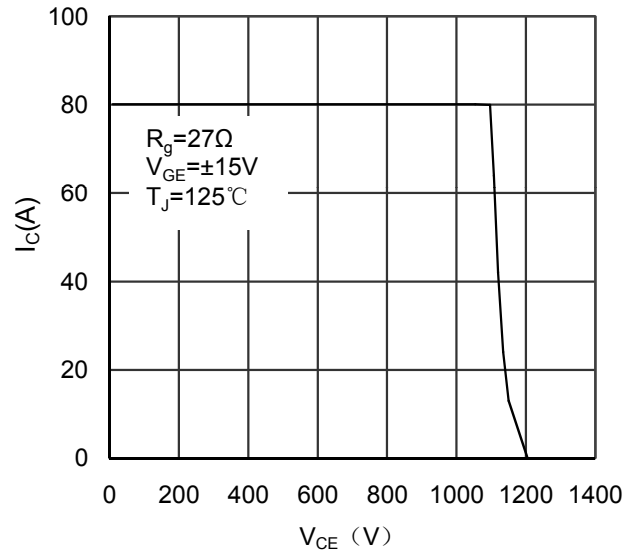

Figure 6. Reverse Biased Safe Operating Area IGBT-inverter

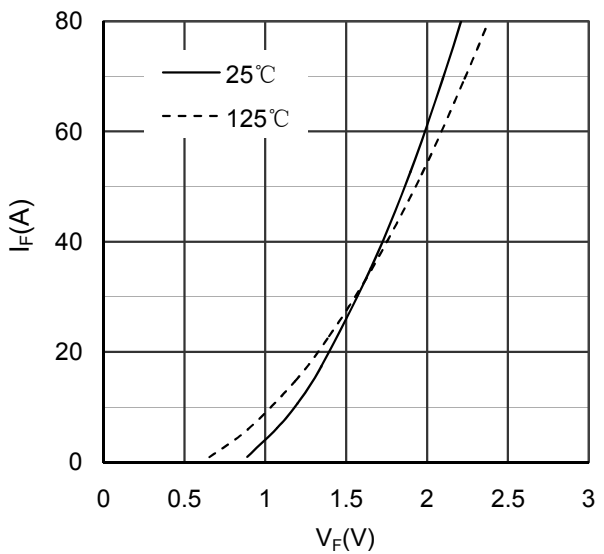

Figure 7. Diode Forward Characteristics Diode -inverter

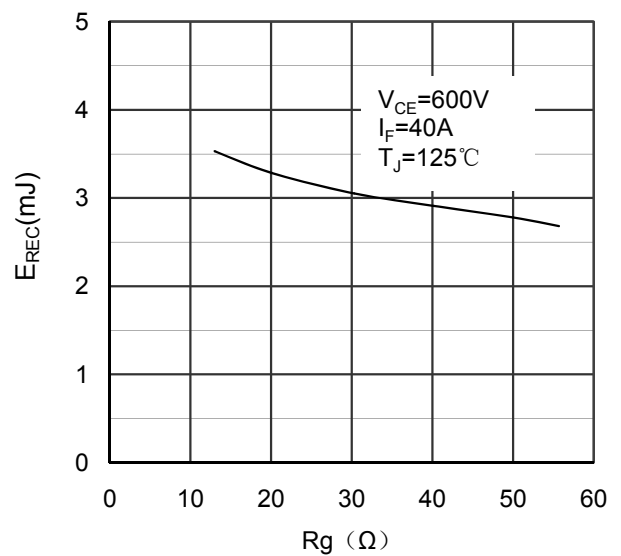

Figure 8. Switching Energy vs Gate Resistor Diode -inverter

# MMG40W120XB6TN

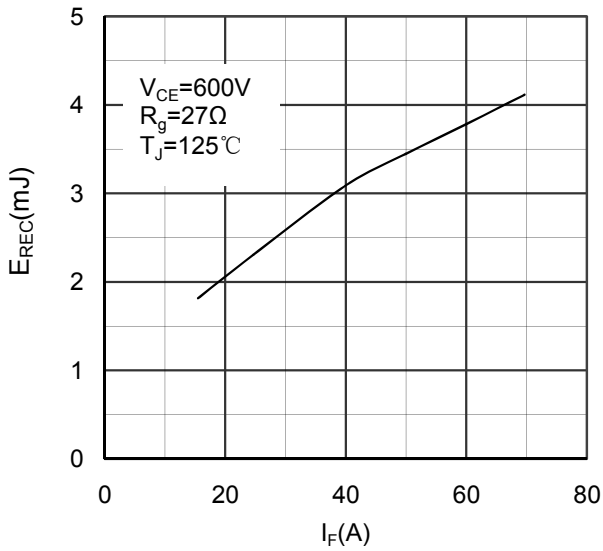

Figure 9. Switching Energy vs Forward Current Diode-inverter

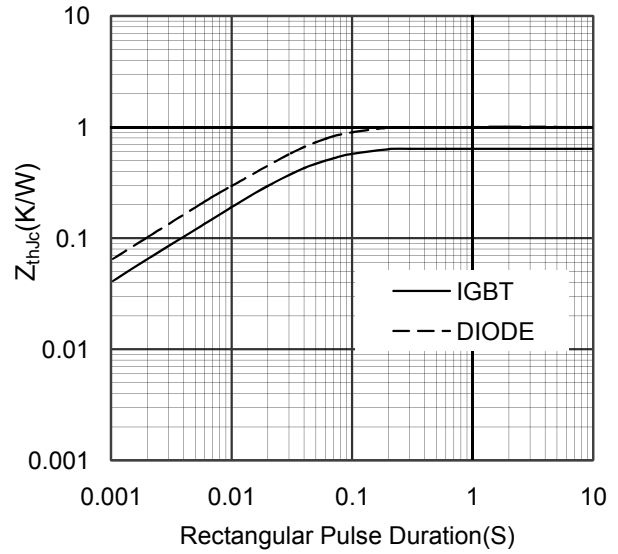

Figure 10. Transient Thermal Impedance of Diode and IGBT-inverter

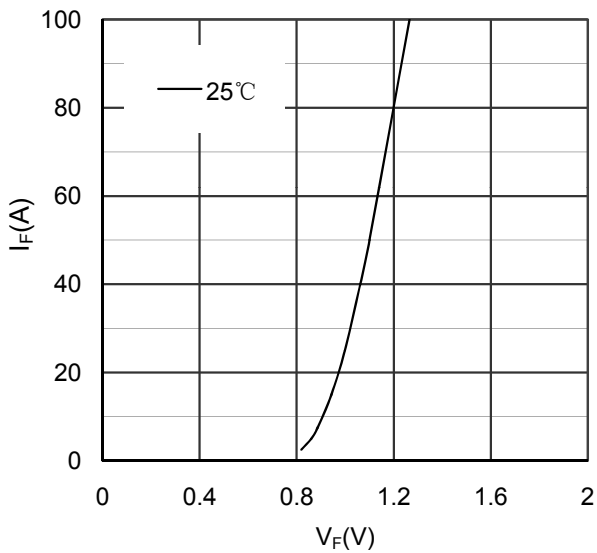

Figure 11. Diode Forward Characteristics Diode-rectifier

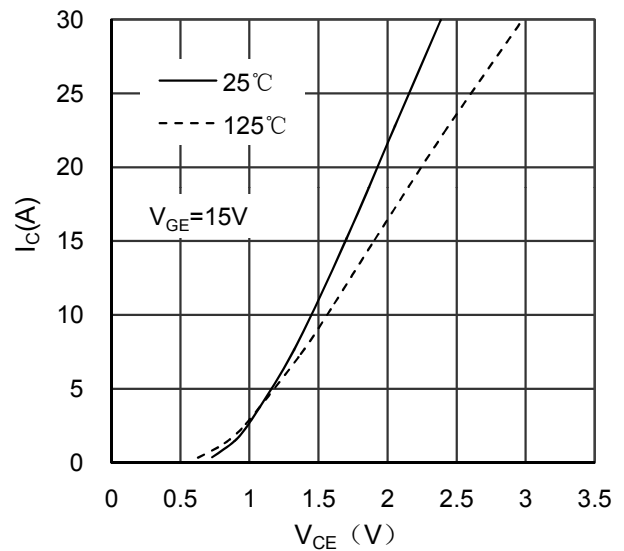

Figure 12. Typical Output Characteristics IGBT-brake chopper

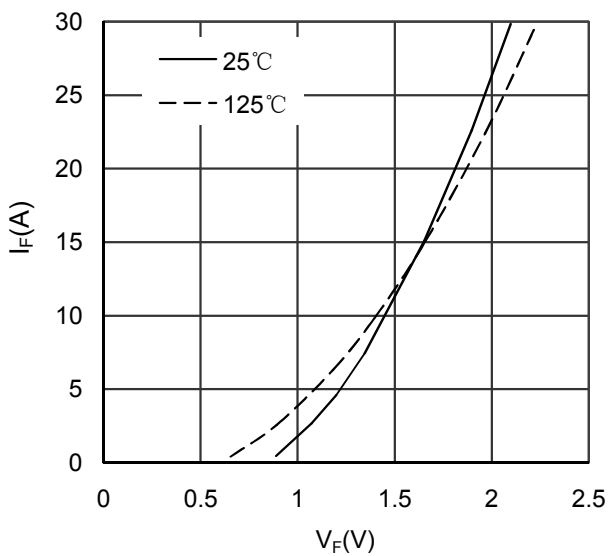

Figure 13. Diode Forward Characteristics Diode-brake chopper

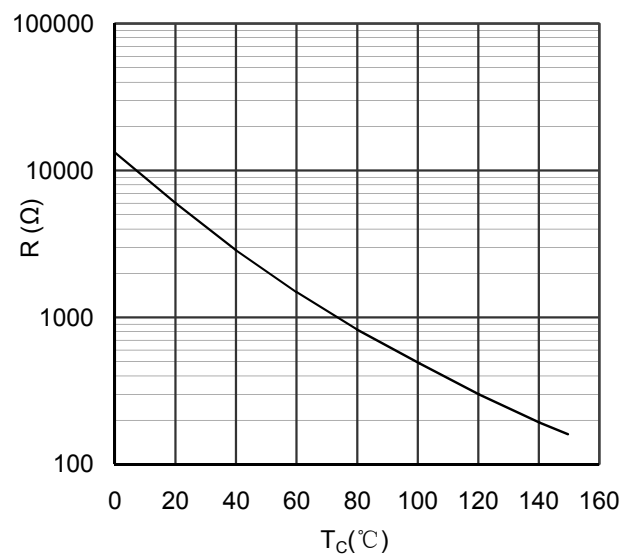

Figure 14. NTC Characteristics

# MMG40W120XB6TN

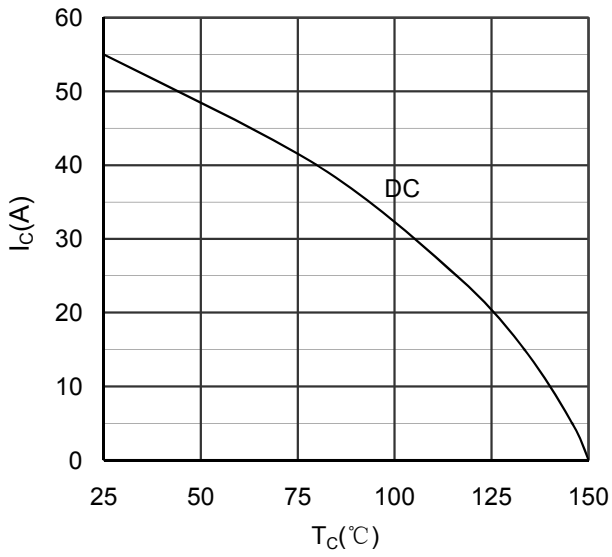

Figure 15. Collector Current vs Case temperature IGBT-inverter

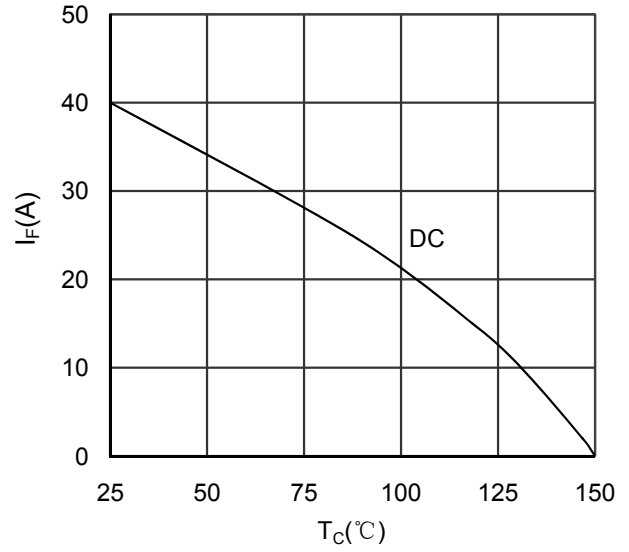

Figure 16. Forward current vs Case temperature Diode-inverter

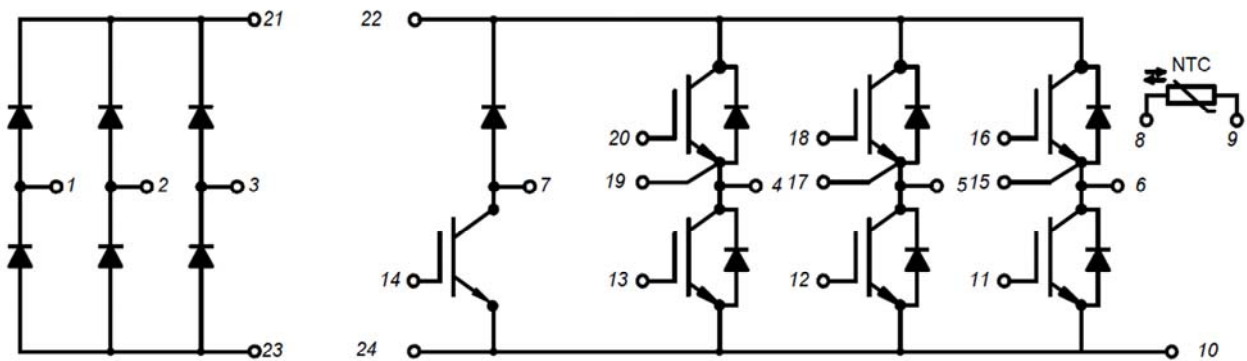
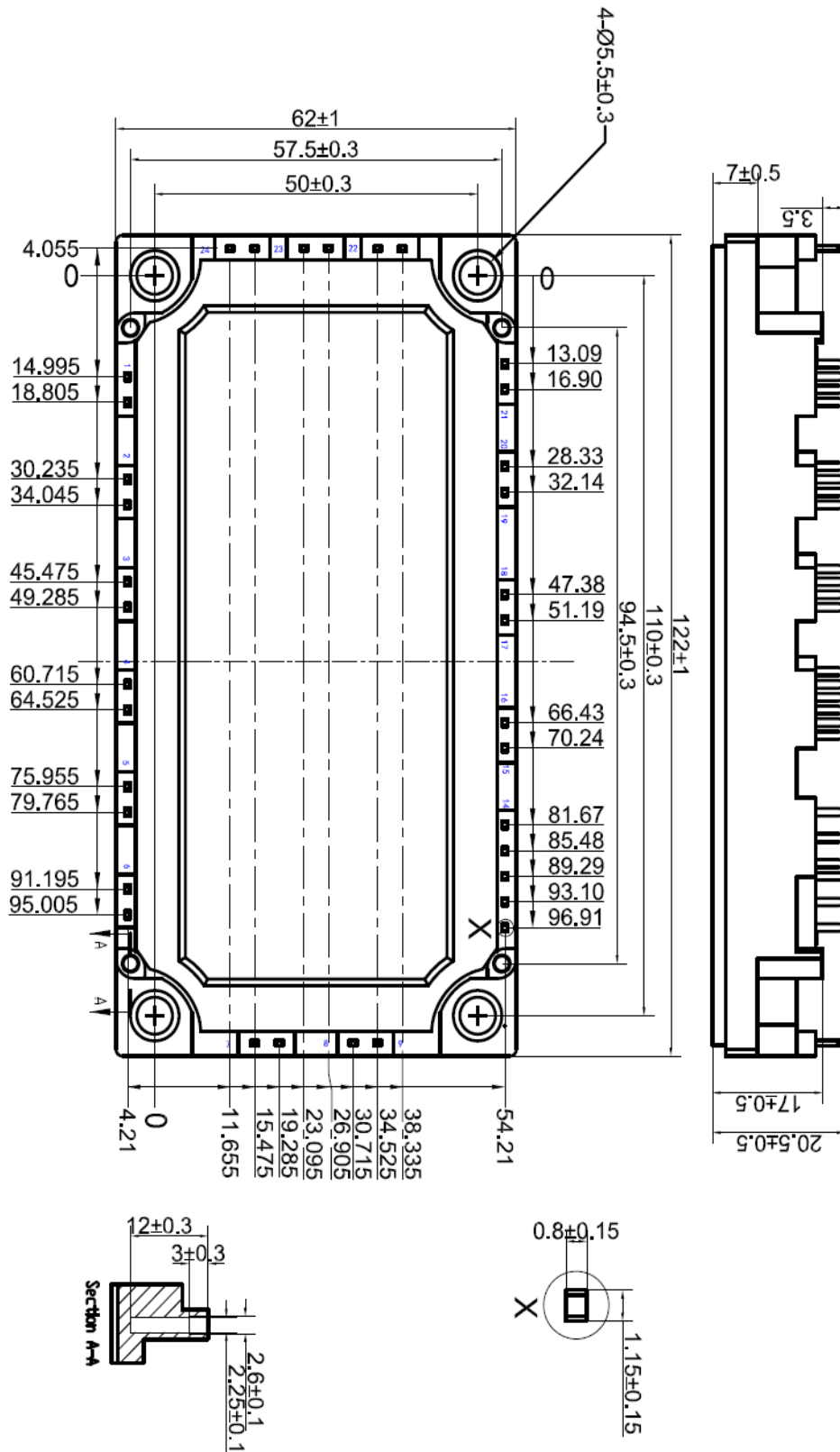

Figure 17. Circuit Diagram



MMG40W120XB6TN



Dimensions in (mm)  
Figure 18. Package Outline