

PRODUCT FEATURES

- IGBT³ CHIP(Trench+Field Stop technology)
- Low saturation voltage and positive temperature coefficient
- Fast switching and short tail current
- Free wheeling diodes with fast and soft reverse recovery
- Temperature sense included



APPLICATIONS

- AC motor control
- Motion/servo control
- Inverter and power supplies
- Photovoltaic/Fuel cell

IGBT-inverter

ABSOLUTE MAXIMUM RATINGS

T_C=25°C unless otherwise specified

Symbol	Parameter/Test Conditions		Values	Unit
V _{CES}	Collector Emitter Voltage	T _J =25°C	1200	V
V _{GES}	Gate Emitter Voltage		±20	
I _C	DC Collector Current	T _C =25°C	600	A
		T _C =80°C	450	
I _{CM}	Repetitive Peak Collector Current	tp=1ms	900	
P _{tot}	Power Dissipation Per IGBT		1950	W

Diode-inverter

ABSOLUTE MAXIMUM RATINGS

T_C=25°C unless otherwise specified

Symbol	Parameter/Test Conditions		Values	Unit
V _{RRM}	Repetitive Reverse Voltage	T _J =25°C	1200	V
I _{F(AV)}	Average Forward Current	T _C =25°C	450	A
I _{FRM}	Repetitive Peak Forward Current	tp=1ms	900	
i ² t		T _J =125°C, t=10ms, V _R =0V	34	KA ² S

IGBT-inverter

ELECTRICAL CHARACTERISTICS

 $T_C=25^\circ\text{C}$ unless otherwise specified

Symbol	Parameter/Test Conditions		Min.	Typ.	Max.	Unit		
$V_{GE(th)}$	Gate Emitter Threshold Voltage		$V_{CE}=V_{GE}, I_C=18\text{mA}$	5.0	5.8	6.5	V	
$V_{CE(sat)}$	Collector Emitter Saturation Voltage	chip	$I_C=450\text{A}, V_{GE}=15\text{V}, T_J=25^\circ\text{C}$		1.7	2.15		
			$I_C=450\text{A}, V_{GE}=15\text{V}, T_J=125^\circ\text{C}$		2.0			
I_{CES}	Collector Leakage Current		$V_{CE}=1200\text{V}, V_{GE}=0\text{V}, T_J=25^\circ\text{C}$			1	mA	
			$V_{CE}=1200\text{V}, V_{GE}=0\text{V}, T_J=125^\circ\text{C}$			5	mA	
I_{GES}	Gate Leakage Current		$V_{CE}=0\text{V}, V_{GE}=\pm 15\text{V}, T_J=25^\circ\text{C}$	-400		400	nA	
R_{gint}	Integrated Gate Resistor				1.7		Ω	
Q_g	Gate Charge		$V_{CE}=600\text{V}, I_C=450\text{A}, V_{GE}=\pm 15\text{V}$		4.3		μC	
C_{ies}	Input Capacitance		$V_{CE}=25\text{V}, V_{GE}=0\text{V}, f=1\text{MHz}$		32		nF	
C_{res}	Reverse Transfer Capacitance				1.5		nF	
$t_{d(on)}$	Turn on Delay Time		$V_{CC}=600\text{V}, I_C=450\text{A}$ $R_G=1.6\Omega,$ $V_{GE}=\pm 15\text{V},$ Inductive Load	$T_J=25^\circ\text{C}$		160		ns
				$T_J=125^\circ\text{C}$		170		ns
t_r	Rise Time			$T_J=25^\circ\text{C}$		45		ns
				$T_J=125^\circ\text{C}$		50		ns
$t_{d(off)}$	Turn off Delay Time		$V_{CC}=600\text{V}, I_C=450\text{A}$ $R_G=1.6\Omega,$ $V_{GE}=\pm 15\text{V},$ Inductive Load	$T_J=25^\circ\text{C}$		460		ns
				$T_J=125^\circ\text{C}$		530		ns
t_f	Fall Time			$T_J=25^\circ\text{C}$		100		ns
				$T_J=125^\circ\text{C}$		150		ns
E_{on}	Turn on Energy		$V_{CC}=600\text{V}, I_C=450\text{A}$ $R_G=1.6\Omega,$ $V_{GE}=\pm 15\text{V},$ Inductive Load	$T_J=25^\circ\text{C}$		20		mJ
				$T_J=125^\circ\text{C}$		31		mJ
E_{off}	Turn off Energy			$T_J=25^\circ\text{C}$		33		mJ
				$T_J=125^\circ\text{C}$		55		mJ
I_{sc}	Short Circuit Current		$t_{psc}\leq 10\mu\text{s}, V_{GE}=15\text{V}$ $T_J=125^\circ\text{C}, V_{CC}=900\text{V}$		1800		A	
R_{thJC}	Junction to Case Thermal Resistance (Per IGBT)					0.064	K/W	

Diode-inverter

ELECTRICAL CHARACTERISTICS

 $T_C=25^\circ\text{C}$ unless otherwise specified

Symbol	Parameter/Test Conditions		Min.	Typ.	Max.	Unit	
V_F	Forward Voltage	chip	$I_F=450\text{A}, V_{GE}=0\text{V}, T_J=25^\circ\text{C}$		1.65	2.15	V
			$I_F=450\text{A}, V_{GE}=0\text{V}, T_J=125^\circ\text{C}$		1.65		
t_{rr}	Reverse Recovery Time		$I_F=450\text{A}, V_R=600\text{V}$		255		ns
I_{RRM}	Max. Reverse Recovery Current		$di_F/dt=-7200\text{A}/\mu\text{s}$ $T_J=125^\circ\text{C}$		385		A
E_{rec}	Reverse Recovery Energy				38		mJ
R_{thJCD}	Junction to Case Thermal Resistance (Per Diode)					0.12	K/W

NTC CHARACTERISTICS

 $T_C=25^\circ\text{C}$ unless otherwise specified

Symbol	Parameter/Test Conditions		Min.	Typ.	Max.	Unit	
R_{25}	Resistance		$T_C=25^\circ\text{C}$		5		K Ω
$B_{25/50}$	$R_2 = R_{25} \exp [B_{25/50}(1/T_2 - 1/(298.15 \text{ K}))]$				3375		K

MODULE CHARACTERISTICS

$T_C=25^{\circ}\text{C}$ unless otherwise specified

Symbol	Parameter/Test Conditions		Values	Unit
T_{Jmax}	Max. Junction Temperature		150	°C
T_{Jop}	Operating Temperature		-40~125	
T_{stg}	Storage Temperature		-40~125	
V_{isol}	Isolation Breakdown Voltage	AC, 50Hz(R.M.S), t=1minute	3000	V
CTI	Comparative Tracking Index		> 225	
Torque	to heatsink	Recommended (M5)	2.5~5	Nm
	to terminal	Recommended (M6)	3~5	Nm
Weight			350	g

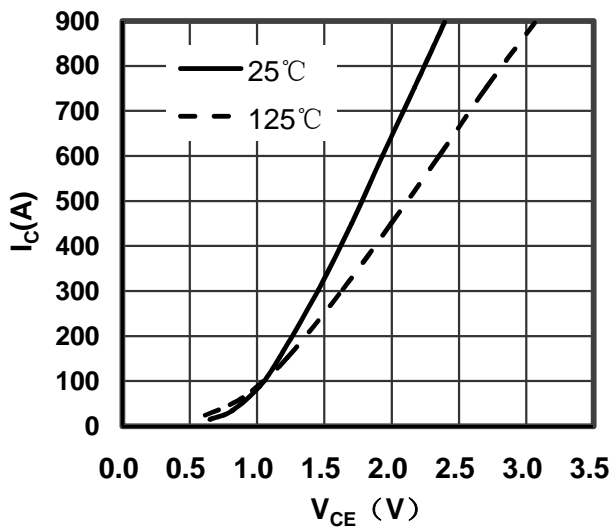

Figure 1. Typical Output Characteristics IGBT-inverter

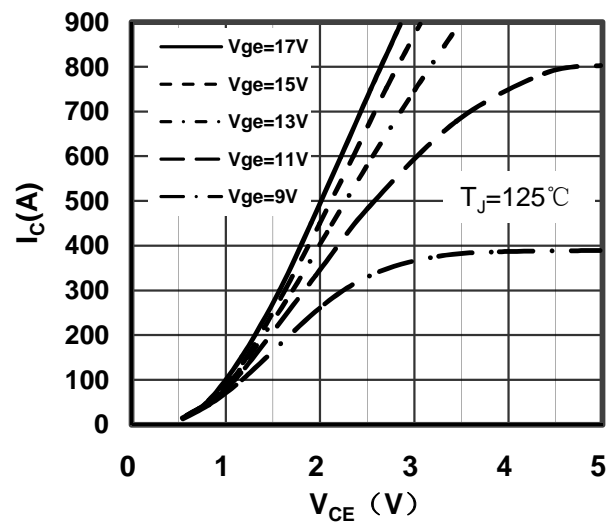

Figure 2. Typical Output Characteristics IGBT-inverter

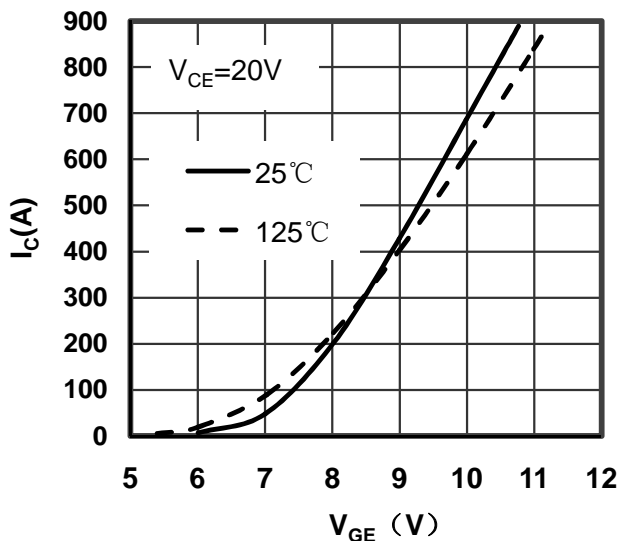

Figure 3. Typical Transfer characteristics IGBT-inverter

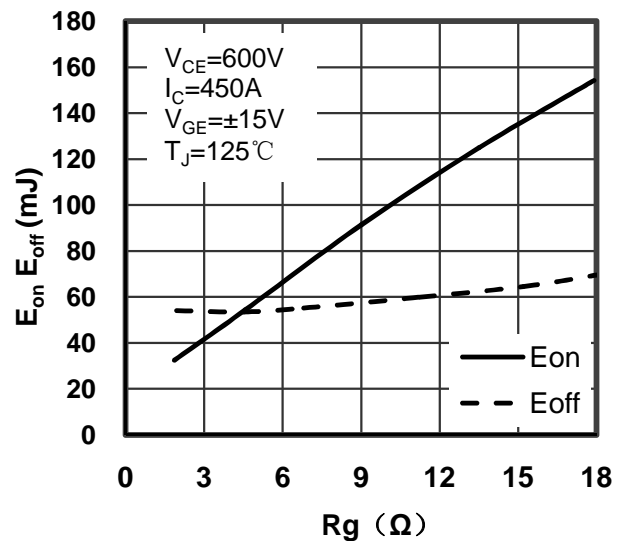

Figure 4. Switching Energy vs Gate Resistor IGBT-inverter

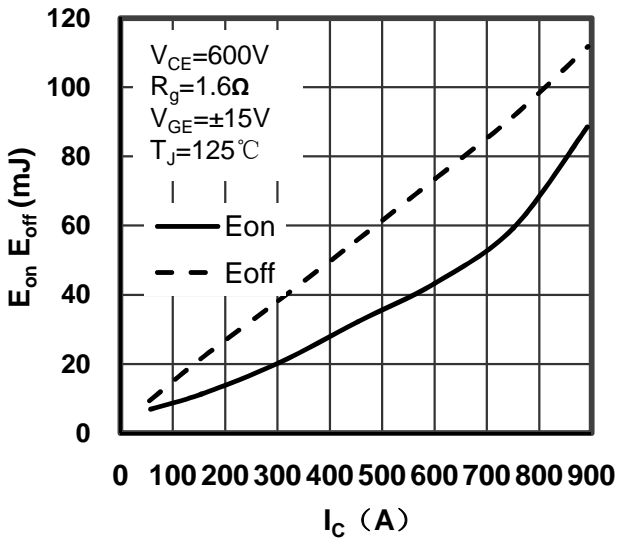

Figure 5. Switching Energy vs Collector Current IGBT-inverter

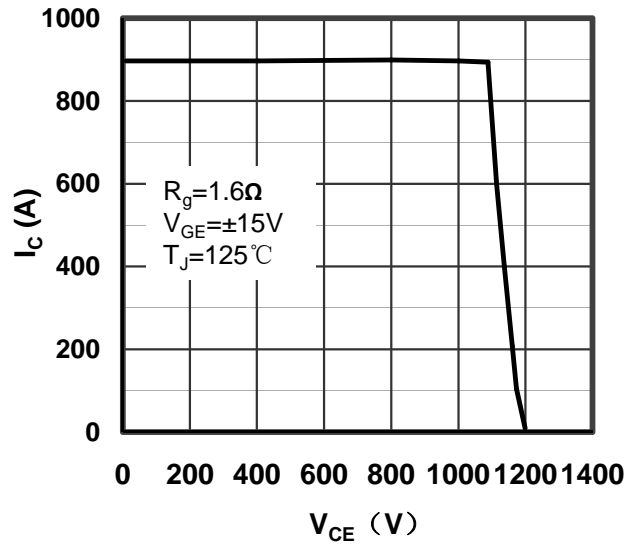

Figure 6. Reverse Biased Safe Operating Area IGBT-inverter

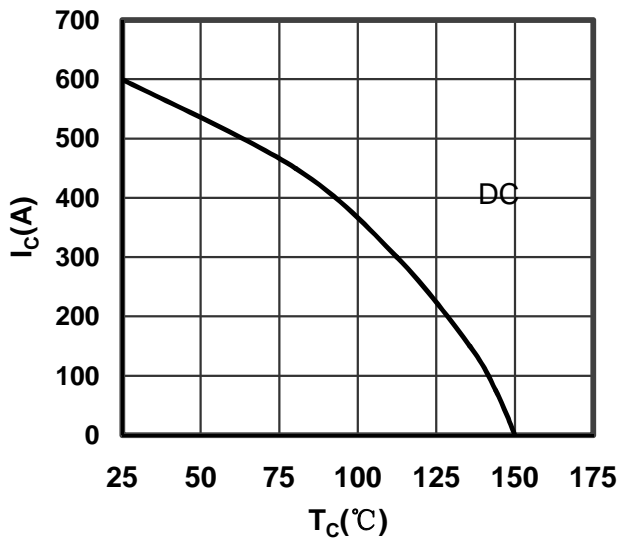

Figure 7. Collector Current vs Case temperature IGBT-inverter

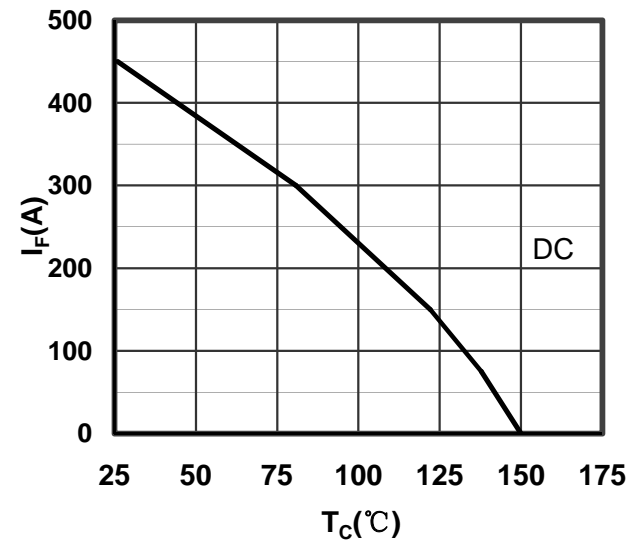

Figure 8. Forward current vs Case temperature Diode-inverter

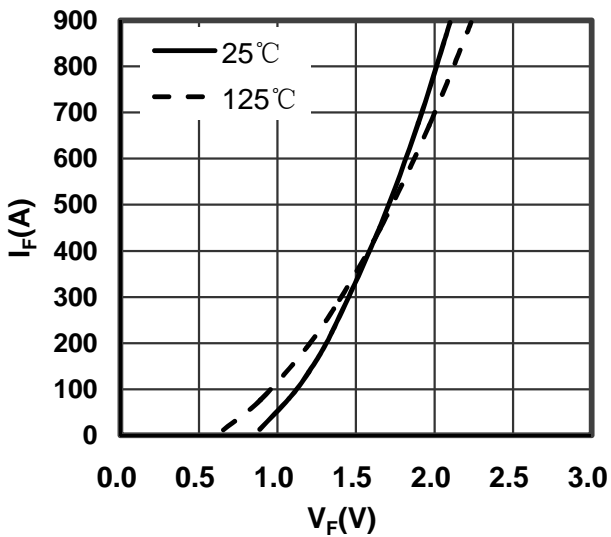

Figure 9. Diode Forward Characteristics Diode-inverter

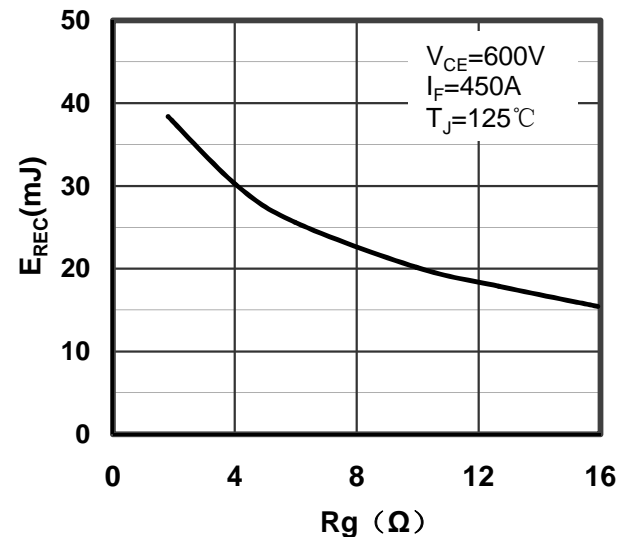

Figure 10. Switching Energy vs Gate Resistor Diode-inverter

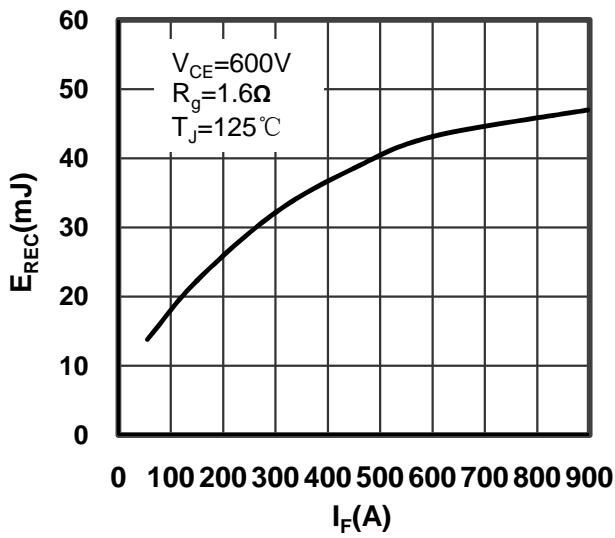

Figure 11. Switching Energy vs Forward Current Diode-inverter

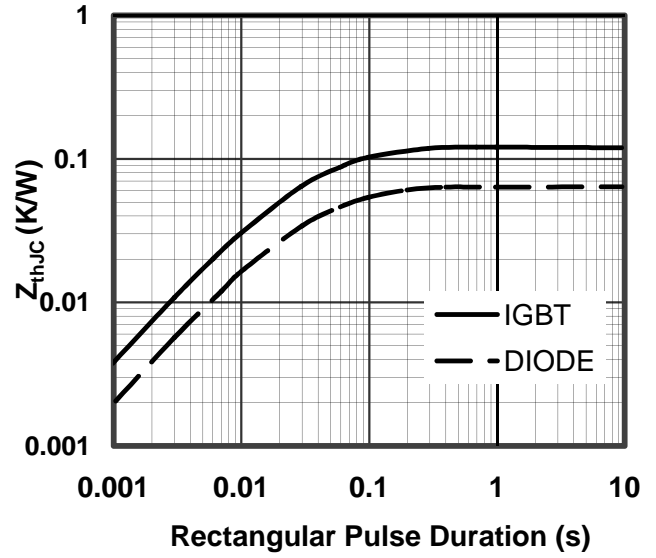

Figure 12. Transient Thermal Impedance of Diode and IGBT-inverter

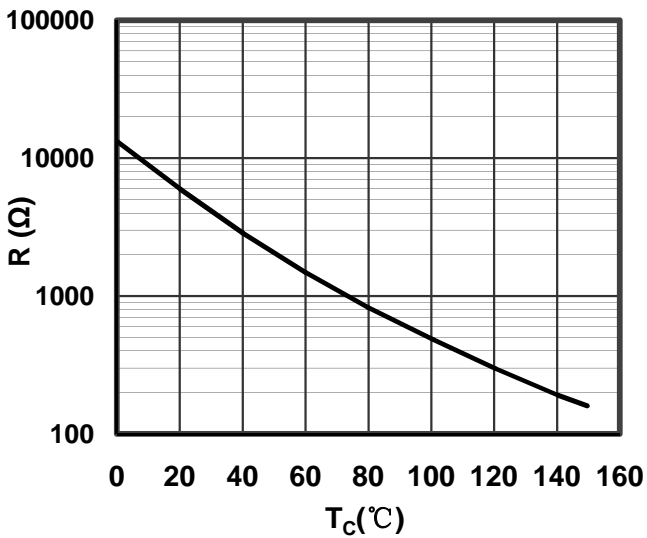

Figure 13. NTC Characteristics

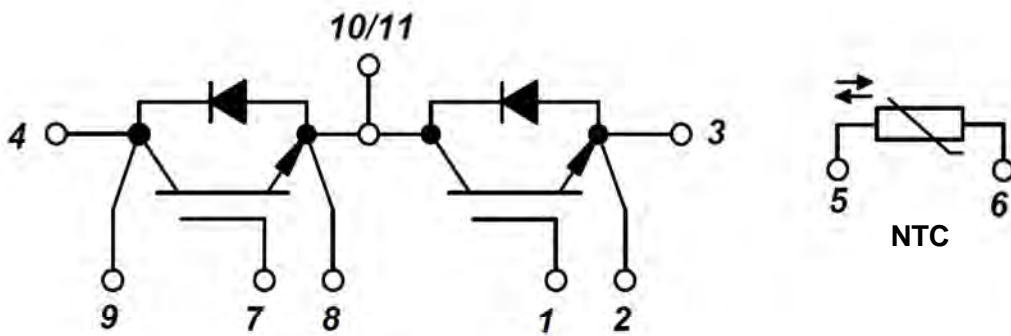
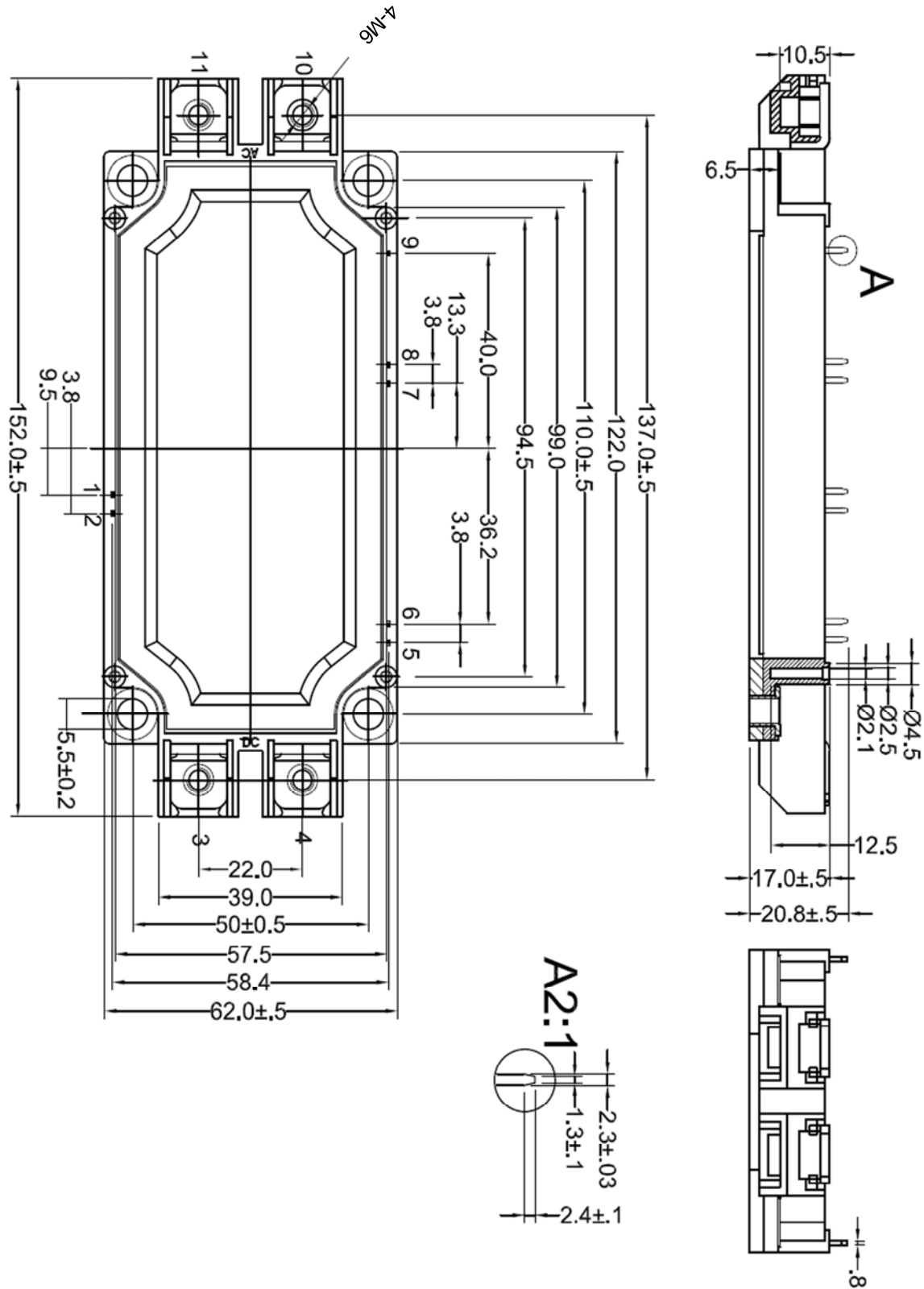

Figure 14. Circuit Diagram



Dimensions in (mm)
Figure 15. Package Outline