

## PRODUCT FEATURES

- High Short Circuit Capability
- Free wheeling diodes with fast and soft reverse recovery
- $V_{CE(sat)}$  with positive temperature coefficient
- Ultra Low Loss, High Ruggedness
- Popular SOT-227 Package



## APPLICATIONS

- Inverter Convertor
- Welder SMPS and UPS
- Induction Heating

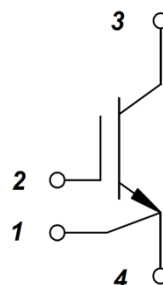

## IGBT

### ABSOLUTE MAXIMUM RATINGS

$T_C = 25^\circ\text{C}$  unless otherwise specified

Symbol	Parameter/Test Conditions		Values	Unit
$V_{CES}$	Collector Emitter Voltage	$T_J = 25^\circ\text{C}$	1200	V
$V_{GES}$	Gate Emitter Voltage		$\pm 20$	
$I_C$	DC Collector Current	$T_C = 25^\circ\text{C}$	105	A
		$T_C = 80^\circ\text{C}$	75	
$I_{CM}$	Repetitive Peak Collector Current	$t_p = 1\text{ms}$	150	
$P_{tot}$	Power Dissipation Per IGBT		630	W

### MODULE CHARACTERISTICS

$T_C = 25^\circ\text{C}$  unless otherwise specified

Symbol	Parameter/Test Conditions		Values	Unit
$T_{Jmax}$	Max. Junction Temperature		150	$^\circ\text{C}$
$T_{Jop}$	Operating Temperature		-40~125	
$T_{stg}$	Storage Temperature		-40~125	
$V_{isol}$	Isolation Breakdown Voltage	AC, 50Hz(R.M.S), $t = 1\text{minute}$	3000	V
Torque	to heatsink	Recommended (M4)	0.7~1.1	Nm
	to terminal	Recommended (M4)	0.7~1.1	Nm
Weight			26.5	g

# IGBT

## ELECTRICAL CHARACTERISTICS

$T_C = 25^\circ\text{C}$  unless otherwise specified

Symbol	Parameter/Test Conditions		Min.	Typ.	Max.	Unit	
$V_{GE(th)}$	Gate Emitter Threshold Voltage	$V_{CE}=V_{GE}, I_C=3\text{mA}$	5.0	6.2	7.0	V	
$V_{CE(sat)}$	Collector Emitter Saturation Voltage	$I_C=75\text{A}, V_{GE}=15\text{V}, T_J=25^\circ\text{C}$		1.8	2.4		
		$I_C=75\text{A}, V_{GE}=15\text{V}, T_J=125^\circ\text{C}$		2.0			
$I_{CES}$	Collector Leakage Current	$V_{CE}=1200\text{V}, V_{GE}=0\text{V}, T_J=25^\circ\text{C}$			1	mA	
		$V_{CE}=1200\text{V}, V_{GE}=0\text{V}, T_J=125^\circ\text{C}$			10	mA	
$I_{GES}$	Gate Leakage Current	$V_{CE}=0\text{V}, V_{GE}=\pm 15\text{V}, T_J=25^\circ\text{C}$	-400		400	nA	
$R_{gint}$	Integrated Gate Resistor			3		$\Omega$	
$Q_g$	Gate Charge	$V_{CE}=600\text{V}, I_C=75\text{A}, V_{GE}=\pm 15\text{V}$		0.75		$\mu\text{C}$	
$C_{ies}$	Input Capacitance	$V_{CE}=25\text{V}, V_{GE}=0\text{V}, f=1\text{MHz}$		5.52		nF	
$C_{res}$	Reverse Transfer Capacitance				260		pF
$t_{d(on)}$	Turn on Delay Time	$V_{CC}=600\text{V}, I_C=75\text{A}$ $R_G=10\Omega,$ $V_{GE}=\pm 15\text{V},$ Inductive Load	$T_J=25^\circ\text{C}$		100		ns
			$T_J=125^\circ\text{C}$		110		ns
$t_r$	Rise Time		$T_J=25^\circ\text{C}$		60		ns
			$T_J=125^\circ\text{C}$		60		ns
$t_{d(off)}$	Turn off Delay Time	$V_{CC}=600\text{V}, I_C=75\text{A}$ $R_G=10\Omega,$ $V_{GE}=\pm 15\text{V},$ Inductive Load	$T_J=25^\circ\text{C}$		410		ns
			$T_J=125^\circ\text{C}$		450		ns
$t_f$	Fall Time		$T_J=25^\circ\text{C}$		60		ns
			$T_J=125^\circ\text{C}$		75		ns
$E_{on}$	Turn on Energy	$V_{CC}=600\text{V}, I_C=75\text{A}$ $R_G=10\Omega,$ $V_{GE}=\pm 15\text{V},$ Inductive Load	$T_J=25^\circ\text{C}$		5.5		mJ
			$T_J=125^\circ\text{C}$		7		mJ
$E_{off}$	Turn off Energy		$T_J=25^\circ\text{C}$		4.8		mJ
			$T_J=125^\circ\text{C}$		7.0		mJ
$I_{sc}$	Short Circuit Current	$tp_{sc} \leq 10\mu\text{s}, V_{GE}=15\text{V}$ $T_J=125^\circ\text{C}, V_{CC}=900\text{V}$		420		A	
$R_{thJC}$	Junction to Case Thermal Resistance ( Per IGBT)				0.2	K/W	

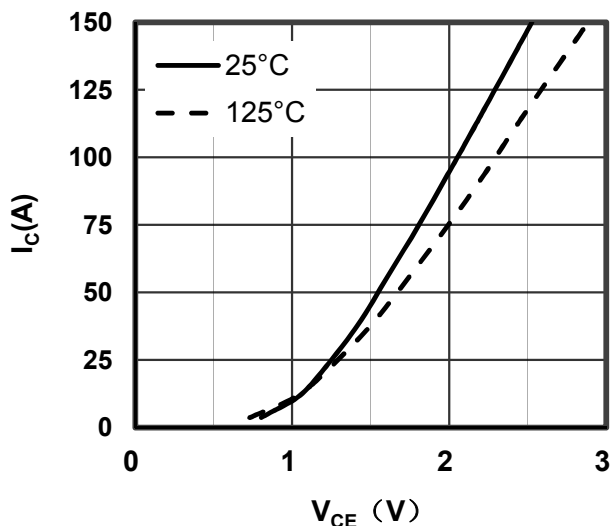

Figure 1. Typical Output Characteristics IGBT

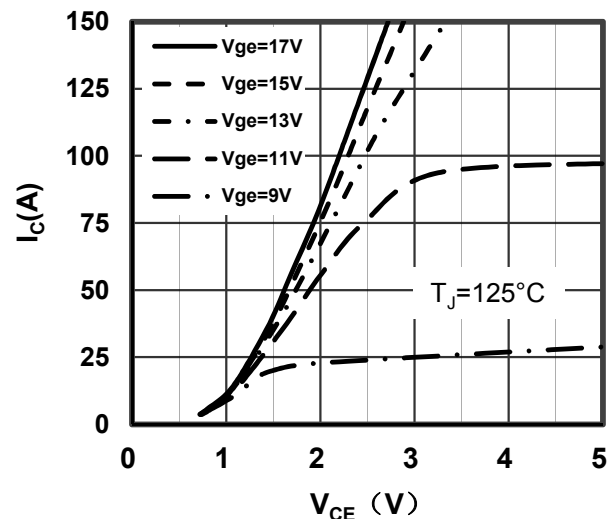

Figure 2. Typical Output Characteristics IGBT

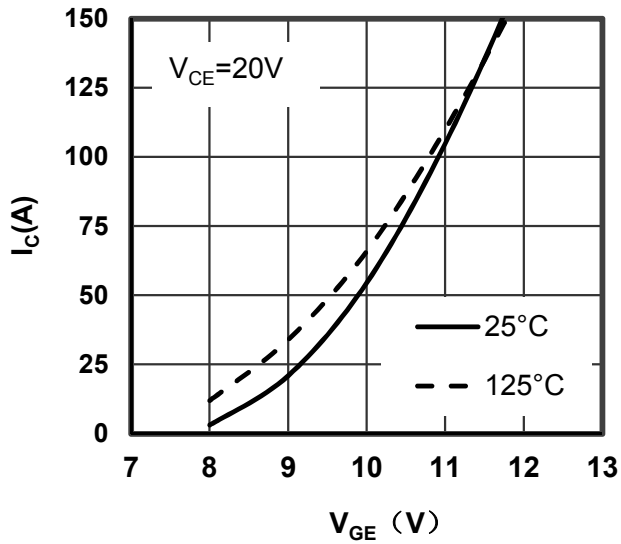

Figure 3. Typical Transfer characteristics IGBT

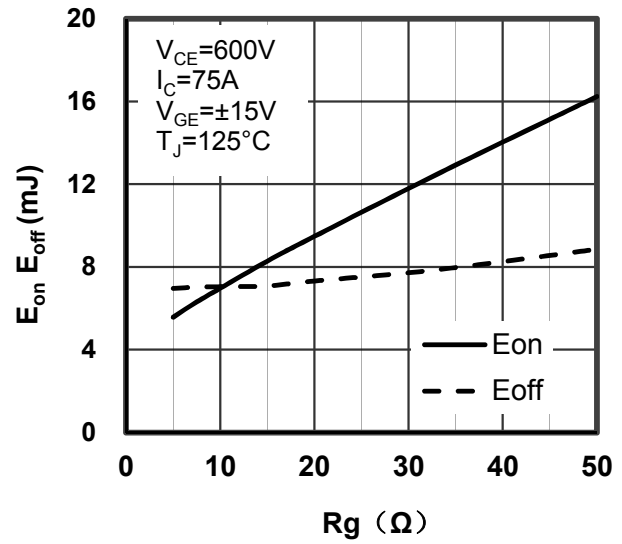

Figure 4. Switching Energy vs Gate Resistor IGBT

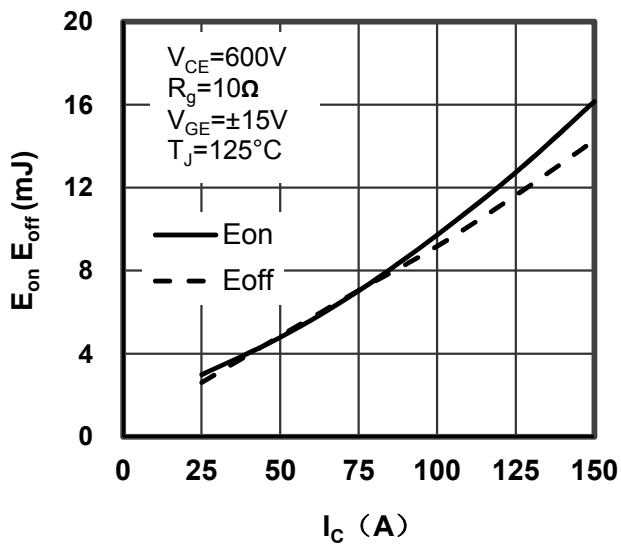

Figure 5. Switching Energy vs Collector Current IGBT

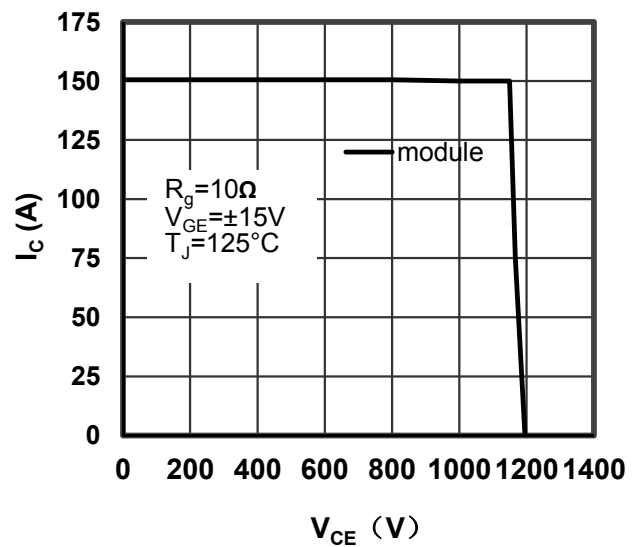

Figure 6. Reverse Biased Safe Operating Area IGBT

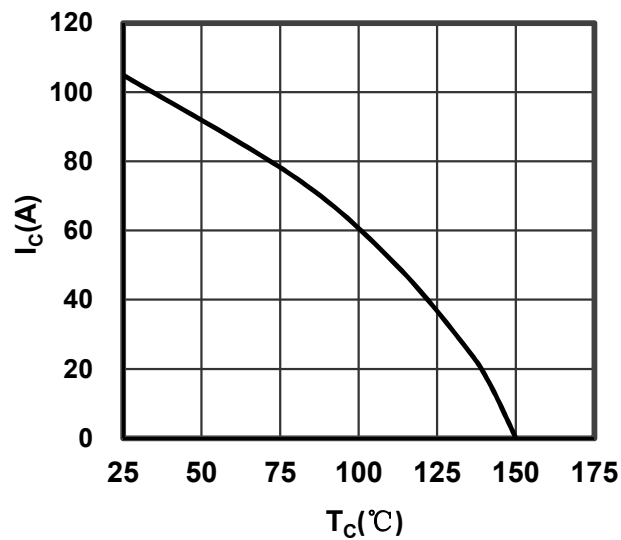

Figure 7. Collector Current vs Case temperature

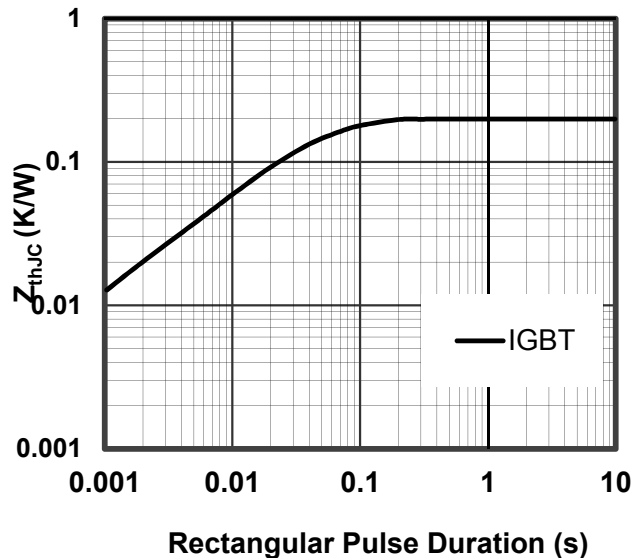
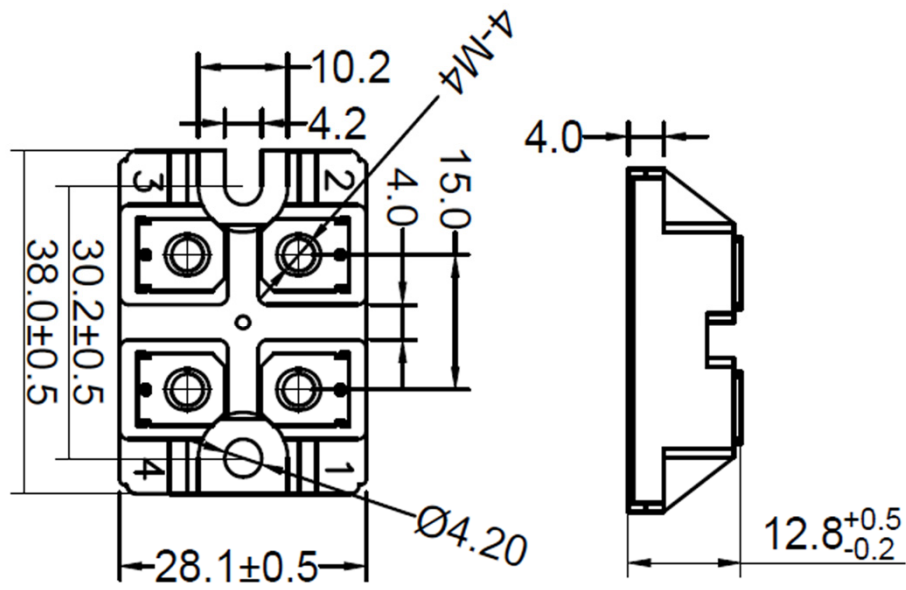

Figure 8. Transient Thermal Impedance of IGBT



Dimensions in (mm)  
Figure 9. Package Outline