

## PRODUCT FEATURES

- Ultrafast Recovery Time
- Low Recovery Loss
- Low Forward Voltage
- Low Leakage Current
- Low Inductance Package



## APPLICATIONS

- Inversion Welder
- Uninterruptible Power Supply
- Plating Power Supply
- Ultrasonic Cleaner and Welder
- Converter & Chopper
- PFC

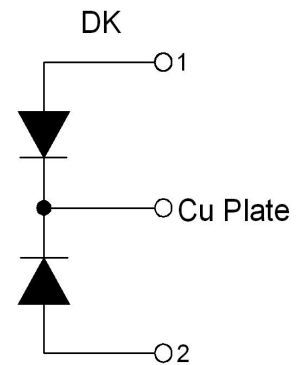

## ABSOLUTE MAXIMUM RATINGS

$T_C = 25^\circ\text{C}$  unless otherwise specified

Symbol	Parameter/Test Conditions		Values	Unit
$V_R$	Maximum D.C. Reverse Voltage		400	V
$V_{RRM}$	Maximum Repetitive Reverse Voltage			
$I_{F(AV)}$	Average Forward Current	TC=100°C, Per Diode	100	A
		TC=100°C, Per Moudle	200	
$I_{F(RMS)}$	RMS Forward Current	TC=100°C, Per Diode	140	
$I_{FSM}$	Non-Repetitive Surge Forward Current	1/2 Cycle, 50Hz, Sine	1000	
		1/2 Cycle, 60Hz, Sine	1100	
$I_2t$	For Fusing	$T_J=45^\circ\text{C}$ , t=10ms, 50Hz, Sine	5000	A <sup>2</sup> S
		$T_J=45^\circ\text{C}$ , t=10ms, 60Hz, Sine	5000	
$P_D$	Power Dissipation		560	W
$T_J$	Junction Temperature		-40 to +150	°C
$T_{STG}$	Storage Temperature Range		-40 to +125	°C
<b>Torque</b>	Module-to-Sink	Recommended (M6)	3~4.7	N.m
	Module Electrodes	Recommended (M6)	3~4.7	N.m
$R_{\theta JC}$	Junction-to-Case Thermal Resistance		0.22	°C/W
<b>Weight</b>			70	g

## ELECTRICAL CHARACTERISTICS

$T_C = 25^\circ\text{C}$  unless otherwise specified

Symbol	Parameter/Test Conditions		Min.	Typ.	Max.	Unit
$I_{RM}$	Maximum Reverse Leakage Current	$V_R = 400\text{V}$			0.5	mA
		$V_R = 400\text{V}, T_J = 125^\circ\text{C}$			1	
$V_F$	Forward Voltage	$I_F = 100\text{A}$		1.1	1.3	V
		$I_F = 100\text{A}, T_J = 125^\circ\text{C}$		1.0		
$t_{rr}$	Reverse Recovery Time ( $I_F = 1\text{A}, diF/dt = -200\text{A}/\mu\text{s}, V_R = 30\text{V}$ )			36		ns
$t_{rr}$	Reverse Recovery Time	$I_F = 100\text{A}, V_R = 200\text{V},$ $diF/dt = -200\text{A}/\mu\text{s}$		75		ns
$I_{RRM}$	Maximum Reverse Recovery Current			8.5		A
$t_{rr}$	Reverse Recovery Time	$I_F = 100\text{A}, V_R = 200\text{V},$ $diF/dt = -200\text{A}/\mu\text{s}, T_J = 125^\circ\text{C}$		125		ns
$I_{RRM}$	Maximum Reverse Recovery Current			18		A

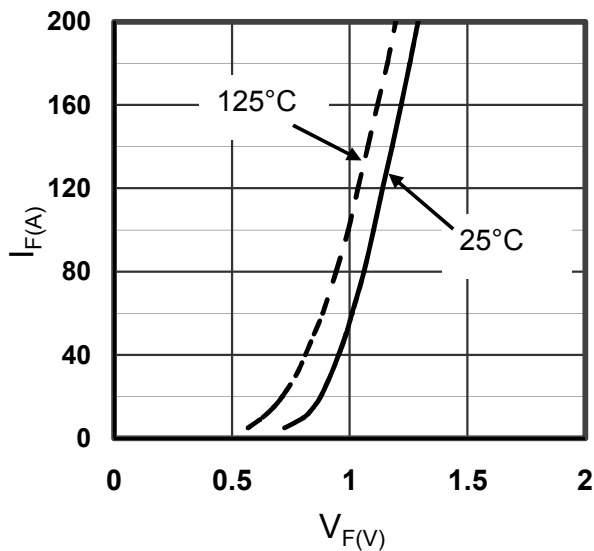

Figure1. Forward Voltage Drop vs Forward Current

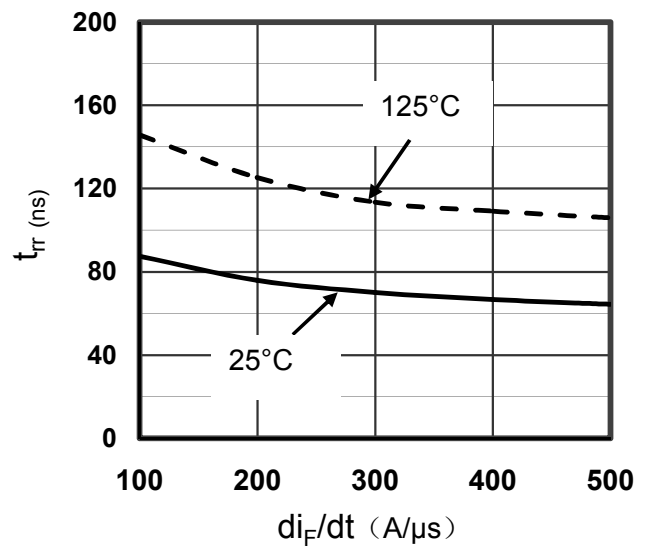

Figure2. Reverse Recovery Time vs diF/dt

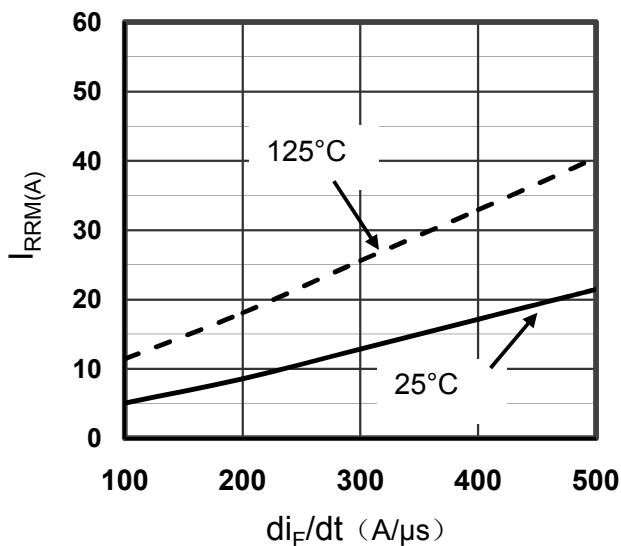

Figure3. Reverse Recovery Current vs diF/dt

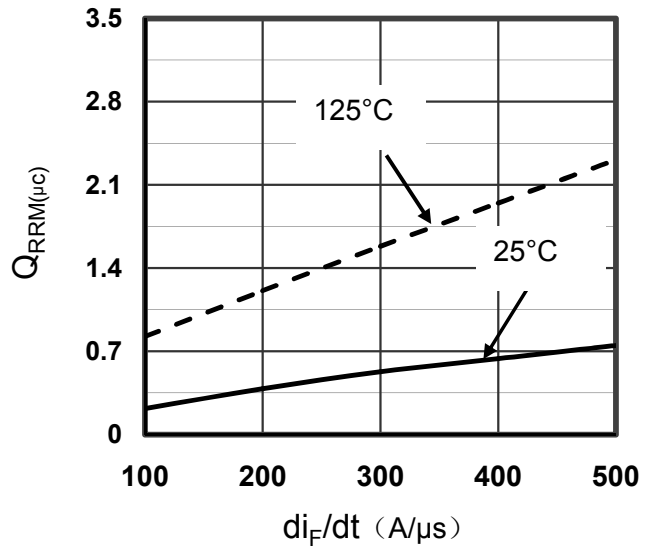

Figure4. Reverse Recovery Charge vs diF/dt

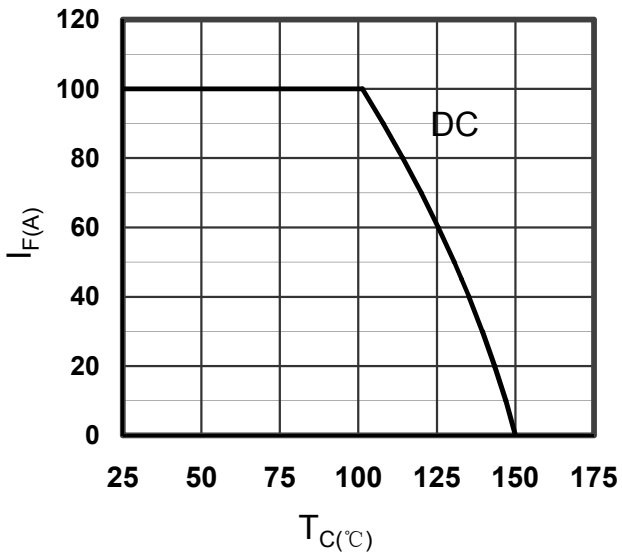

Figure5. Forward current vs. Case temperature

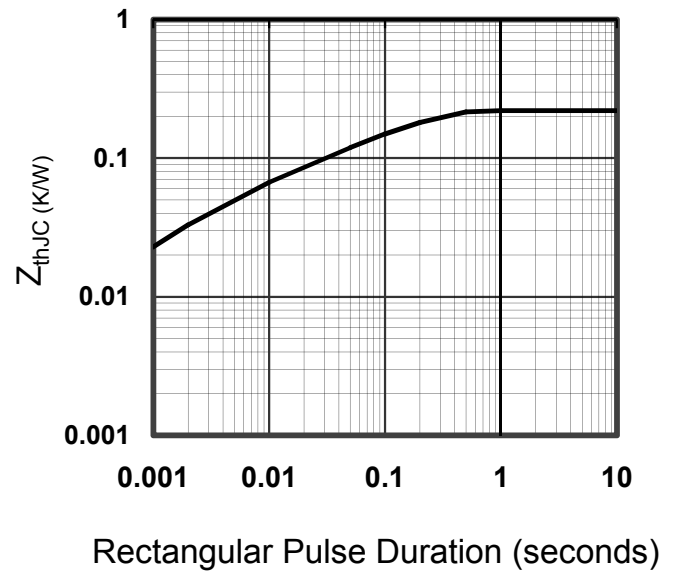
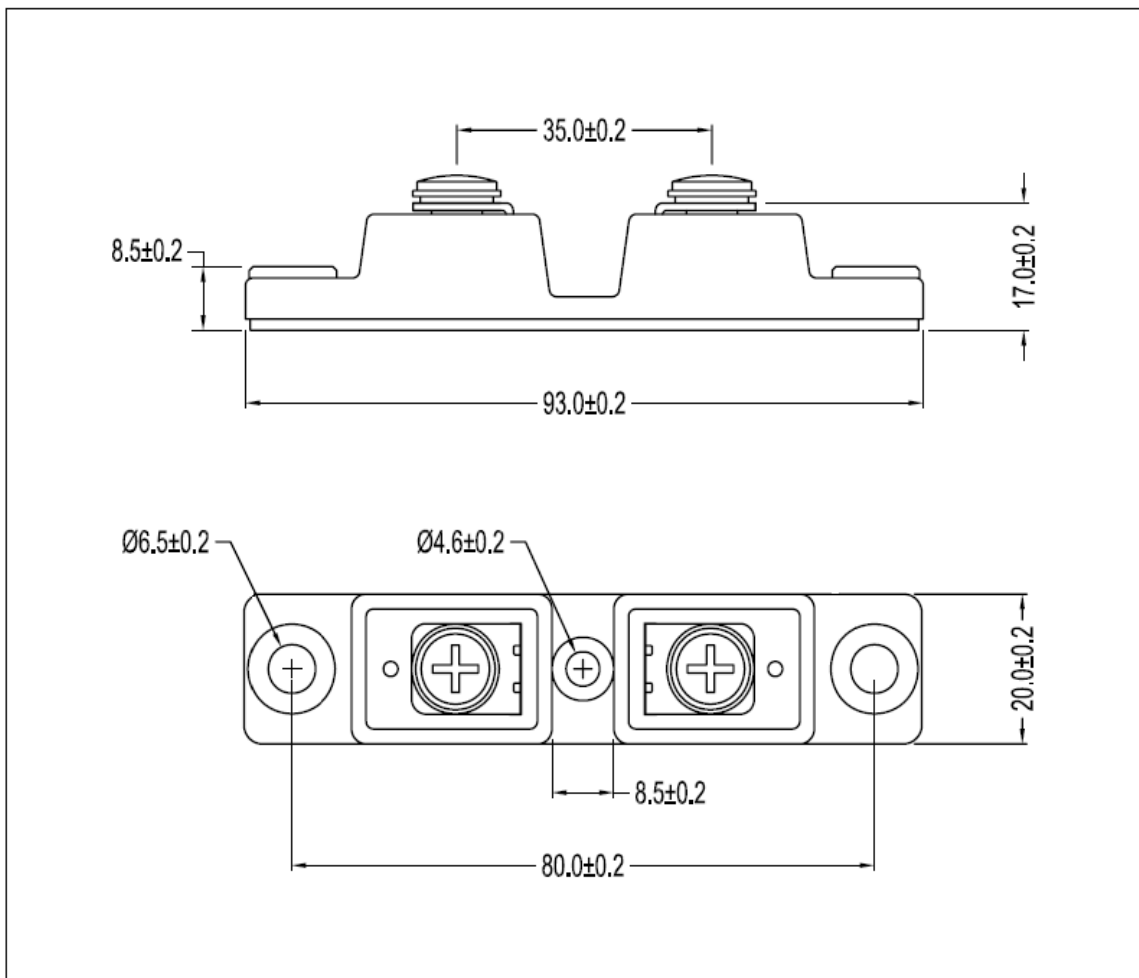

Figure6. Transient Thermal Impedance



Dimensions in Millimeters and (Inchs)  
Figure7. Package Outline