

PRODUCT FEATURES

- Ultrafast Reverse Recovery Time
- Soft Reverse Recovery Characteristics
- Low Reverse Recovery Loss
- Low Forward Voltage
- High Surge Current Capability
- Low Leakage Current



APPLICATIONS

- Inversion Welder
- Uninterruptible Power Supply
- Plating Power Supply
- Ultrasonic Cleaner and Welder
- Converter & Chopper
- PFC

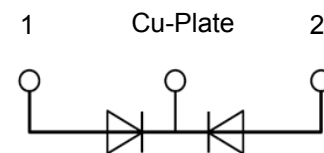

ABSOLUTE MAXIMUM RATINGS($T_C = 25^\circ\text{C}$ unless otherwise specified)

Symbol	Parameter/Test Conditions		Values	Unit
V_R	Maximum D.C. Reverse Voltage		400	V
V_{RRM}	Maximum Repetitive Reverse Voltage			
$I_{F(AV)}$	Average Forward Current	$T_C = 90^\circ\text{C}$, Per Diode	100	A
		$T_C = 90^\circ\text{C}$, Per Module	200	
$I_{F(RMS)}$	RMS Forward Current	$T_C = 90^\circ\text{C}$, Per Diode	140	
I_{FSM}	Non Repetitive Surge Forward Current	$T_J = 45^\circ\text{C}$, $t = 10\text{ms}$, Sine, peak value	700	
		$T_J = 45^\circ\text{C}$, $t = 8.3\text{ms}$, Sine, peak value	760	
I^2t	For Fusing	$T_J = 45^\circ\text{C}$, $t = 10\text{ms}$, Sine, peak value	2450	A^2S
		$T_J = 45^\circ\text{C}$, $t = 8.3\text{ms}$, Sine, peak value	2400	
P_D	Power Dissipation		338	W
T_J	Junction Temperature		-40 to +150	$^\circ\text{C}$
T_{STG}	Storage Temperature Range		-40 to +125	$^\circ\text{C}$
Torque	Module to Sink	Recommended (M6)	3~4.7	Nm
Torque	Module Electrodes	Recommended (M6)	3~4.7	Nm
R_{thJC}	Junction to Case Thermal Resistance(Per Diode)		0.37	$^\circ\text{C}/\text{W}$
Weight			70	g

MacMic Science & Technology Co., Ltd.

Add: #18, Hua Shan Zhong Lu, New District, Changzhou City, Jiangsu Province, P. R. of China

MMF200ZB040DK1D

ELECTRICAL CHARACTERISTICS ($T_C=25^\circ\text{C}$ unless otherwise specified)

Symbol	Parameter/Test Conditions	Min.	Typ.	Max.	Unit
I_{RM}	Maximum Reverse Leakage Current	$V_R = 400\text{V}$		500	μA
		$V_R = 400\text{V}, T_J = 125^\circ\text{C}$		10	mA
V_F	Forward Voltage	$I_F = 100\text{A}$	1.25	1.5	V
		$I_F = 100\text{A}, T_J = 125^\circ\text{C}$	1.15		
t_{rr}	Reverse Recovery Time ($I_F = 1\text{A}, di_F/dt = -200\text{A}/\mu\text{s}, V_R = 30\text{V}$)		28		ns
t_{rr}	Reverse Recovery Time		49		ns
I_{RRM}	Maximum Reverse Recovery Current		7		A
t_{rr}	Reverse Recovery Time		90		ns
I_{RRM}	Maximum Reverse Recovery Current		11		A

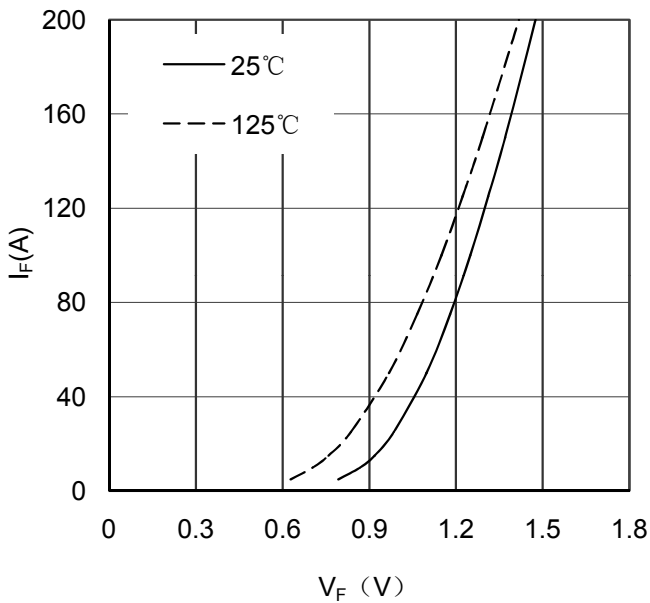

Figure 1. Forward Voltage Drop vs Forward Current

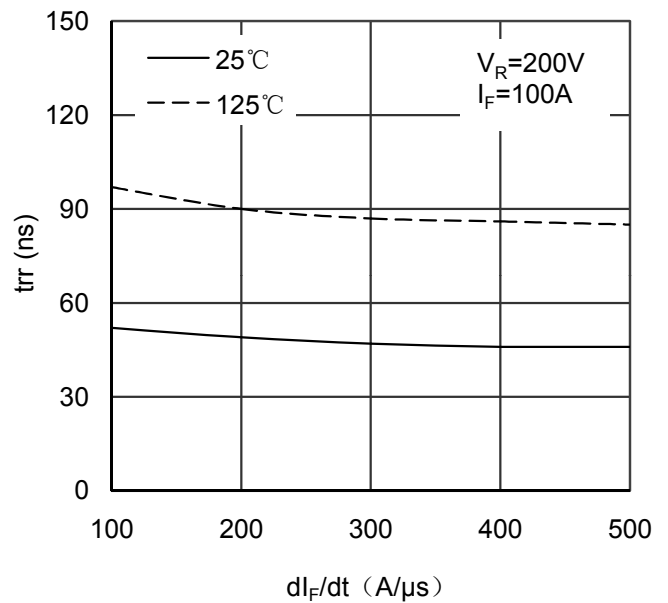

Figure 2. Reverse Recovery Time vs di_F/dt

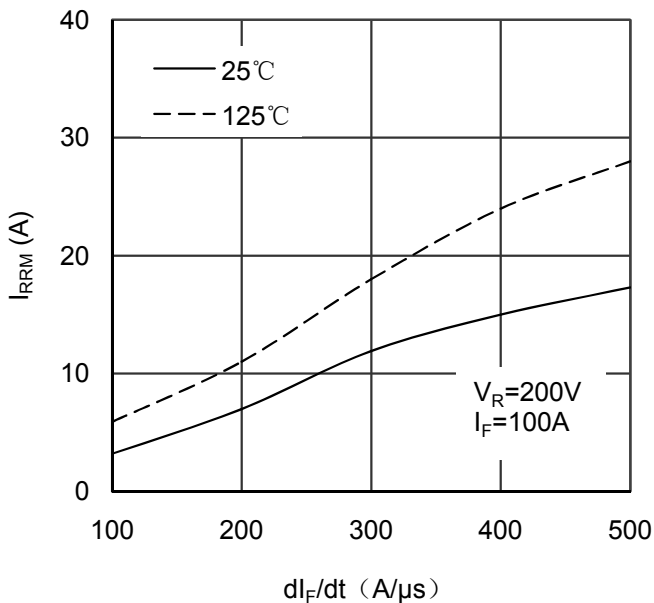

Figure 3. Reverse Recovery Current vs di_F/dt

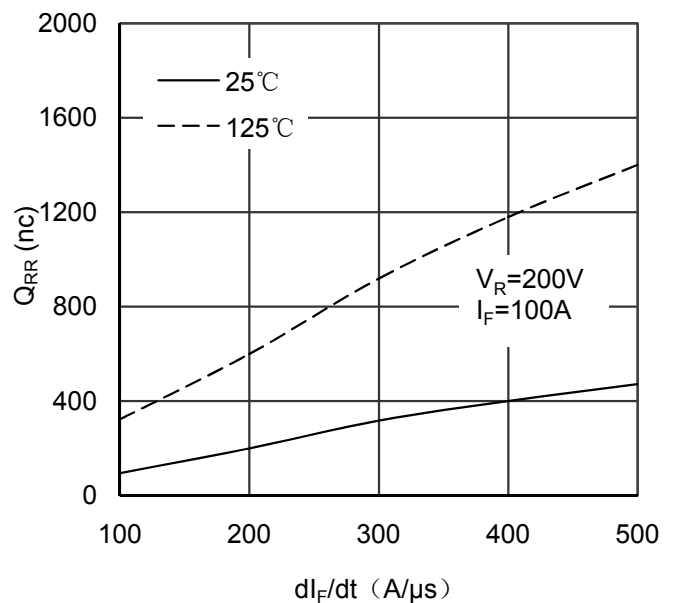

Figure 4. Reverse Recovery Charge vs di_F/dt

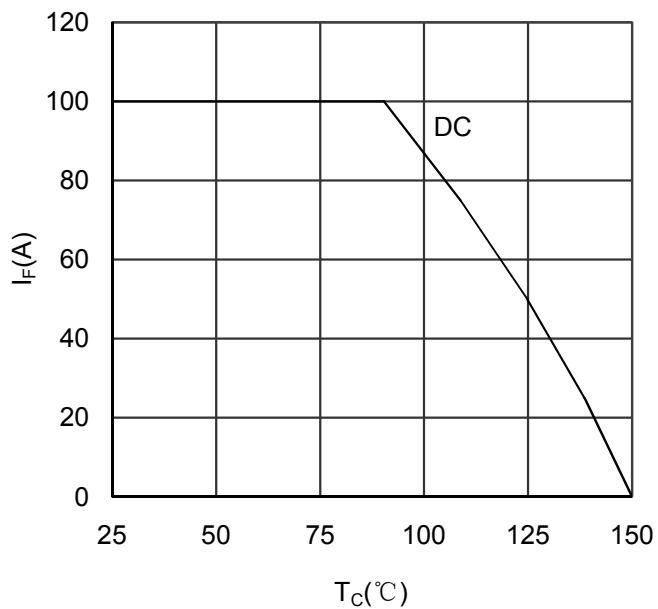

Figure 5. Forward current vs Case temperature

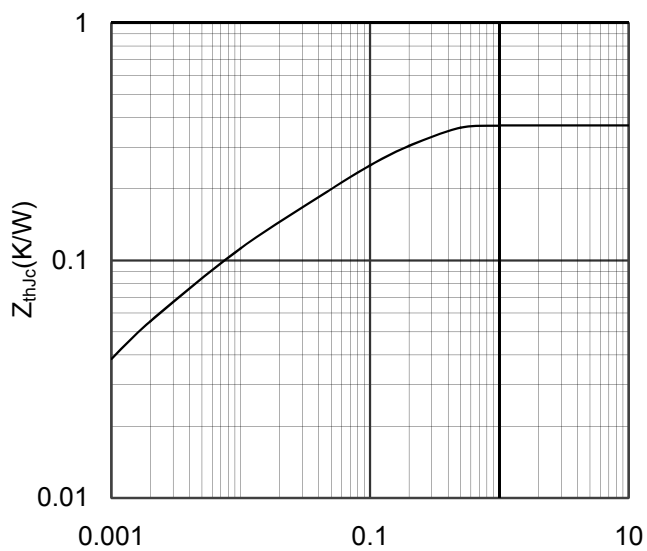
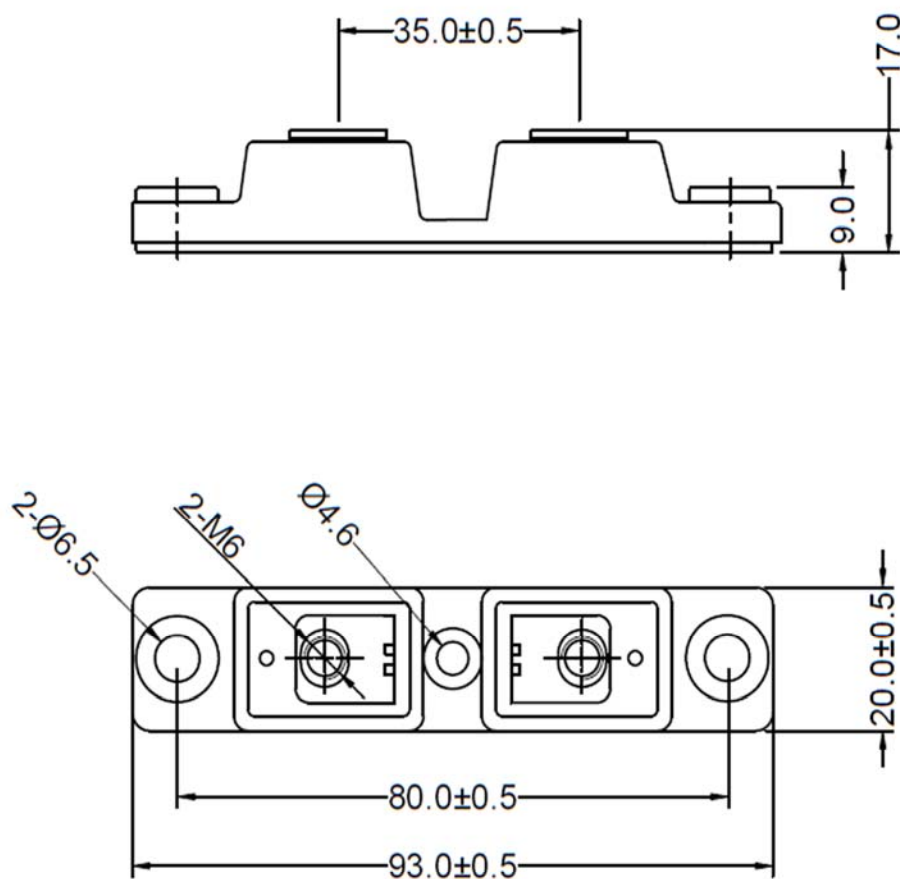

Figure 6. Transient Thermal Impedance



Dimensions in (mm)
Figure 7. Package Outline