

## PRODUCT FEATURES

- IGBT3 CHIP(1700V Trench+Field Stop technology)
- Low turn-off losses, short tail current
- $V_{CE(sat)}$  with positive temperature coefficient
- DIODE CHIP(1700V EMCON 3 technology)
- Free wheeling diodes with fast and soft reverse recovery



## APPLICATIONS

- High frequency switching application
- Medical applications
- Motion/servo control
- UPS systems

## IGBT-inverter

### ABSOLUTE MAXIMUM RATINGS

$T_C=25^{\circ}\text{C}$  unless otherwise specified

Symbol	Parameter/Test Conditions		Values	Unit
$V_{CES}$	Collector Emitter Voltage	$T_J=25^{\circ}\text{C}$	1700	V
$V_{GES}$	Gate Emitter Voltage		$\pm 20$	
$I_C$	DC Collector Current	$T_C=25^{\circ}\text{C}$	400	A
		$T_C=95^{\circ}\text{C}$	300	
$I_{CM}$	Repetitive Peak Collector Current	$t_p=1\text{ms}$	600	
$P_{tot}$	Power Dissipation Per IGBT		1760	W

## Diode-inverter

### ABSOLUTE MAXIMUM RATINGS

$T_C=25^{\circ}\text{C}$  unless otherwise specified

Symbol	Parameter/Test Conditions		Values	Unit
$V_{RRM}$	Repetitive Reverse Voltage	$T_J=25^{\circ}\text{C}$	1700	V
$I_{F(AV)}$	Average Forward Current	$T_C=25^{\circ}\text{C}$	300	A
$I_{FRM}$	Repetitive Peak Forward Current	$t_p=1\text{ms}$	600	
$i^2t$		$T_J=125^{\circ}\text{C}$ , $t=10\text{ms}$ , $V_R=0\text{V}$	14500	$\text{A}^2\text{S}$

**IGBT-inverter**  
**ELECTRICAL CHARACTERISTICS**
 $T_C=25^\circ\text{C}$  unless otherwise specified

Symbol	Parameter/Test Conditions		Min.	Typ.	Max.	Unit	
$V_{GE(th)}$	Gate Emitter Threshold Voltage	$V_{CE}=V_{GE}, I_C=12\text{mA}$	5.2	5.8	6.4	V	
$V_{CE(sat)}$	Collector Emitter Saturation Voltage	$I_C=300\text{A}, V_{GE}=15\text{V}, T_J=25^\circ\text{C}$		2	2.45		
		$I_C=300\text{A}, V_{GE}=15\text{V}, T_J=125^\circ\text{C}$		2.4			
$I_{CES}$	Collector Leakage Current	$V_{CE}=1700\text{V}, V_{GE}=0\text{V}, T_J=25^\circ\text{C}$			1	mA	
		$V_{CE}=1700\text{V}, V_{GE}=0\text{V}, T_J=125^\circ\text{C}$			10	mA	
$I_{GES}$	Gate Leakage Current	$V_{CE}=0\text{V}, V_{GE}=\pm 15\text{V}, T_J=25^\circ\text{C}$	-400		400	nA	
$R_{gint}$	Integrated Gate Resistor			2.5		$\Omega$	
$Q_g$	Gate Charge	$V_{CE}=900\text{V}, I_C=300\text{A}, V_{GE}=\pm 15\text{V}$		3.5		$\mu\text{C}$	
$C_{ies}$	Input Capacitance	$V_{CE}=25\text{V}, V_{GE}=0\text{V}, f=1\text{MHz}$		27		nF	
$C_{res}$	Reverse Transfer Capacitance				900		pF
$t_{d(on)}$	Turn on Delay Time	$V_{CC}=900\text{V}, I_C=300\text{A}$ $R_G=4.7\Omega,$ $V_{GE}=\pm 15\text{V},$ Inductive Load	$T_J=25^\circ\text{C}$		280		ns
			$T_J=125^\circ\text{C}$		380		ns
$t_r$	Rise Time		$T_J=25^\circ\text{C}$		80		ns
			$T_J=125^\circ\text{C}$		100		ns
$t_{d(off)}$	Turn off Delay Time	$V_{CC}=900\text{V}, I_C=300\text{A}$ $R_G=4.7\Omega,$ $V_{GE}=\pm 15\text{V},$ Inductive Load	$T_J=25^\circ\text{C}$		800		ns
			$T_J=125^\circ\text{C}$		1000		ns
$t_f$	Fall Time		$T_J=25^\circ\text{C}$		120		ns
			$T_J=125^\circ\text{C}$		200		ns
$E_{on}$	Turn on Energy	$V_{CC}=900\text{V}, I_C=300\text{A}$ $R_G=4.7\Omega,$ $V_{GE}=\pm 15\text{V},$ Inductive Load	$T_J=25^\circ\text{C}$		71		mJ
			$T_J=125^\circ\text{C}$		105		mJ
$E_{off}$	Turn off Energy		$T_J=25^\circ\text{C}$		64		mJ
			$T_J=125^\circ\text{C}$		94		mJ
$I_{sc}$	Short Circuit Current	$tp_{sc}\leq 10\mu\text{s}, V_{GE}=15\text{V}$ $T_J=125^\circ\text{C}, V_{CC}=1000\text{V}$		1200		A	
$R_{thJC}$	Junction to Case Thermal Resistance ( Per IGBT)				0.085	K/W	

**Diode-inverter**  
**ELECTRICAL CHARACTERISTICS**
 $T_C=25^\circ\text{C}$  unless otherwise specified

Symbol	Parameter/Test Conditions		Min.	Typ.	Max.	Unit
$V_F$	Forward Voltage	$I_F=300\text{A}, V_{GE}=0\text{V}, T_J=25^\circ\text{C}$		1.8	2.2	V
		$I_F=300\text{A}, V_{GE}=0\text{V}, T_J=125^\circ\text{C}$		1.9		
$t_{rr}$	Reverse Recovery Time	$I_F=300\text{A}, V_R=900\text{V}$		700		ns
$I_{RRM}$	Max. Reverse Recovery Current	$di_F/dt=-3600\text{A}/\mu\text{s}$		380		A
$Q_{RR}$	Reverse Recovery Charge	$T_J=125^\circ\text{C}$		130		$\mu\text{C}$
$E_{rec}$	Reverse Recovery Energy				75	
$R_{thJCD}$	Junction to Case Thermal Resistance ( Per Diode)				0.13	K/W

**MODULE CHARACTERISTICS**

$T_C=25^{\circ}\text{C}$  unless otherwise specified

Symbol	Parameter/Test Conditions		Values	Unit
$T_{Jmax}$	Max. Junction Temperature		175	°C
$T_{Jop}$	Operating Temperature		-40~150	
$T_{stg}$	Storage Temperature		-40~125	
$V_{isol}$	Isolation Breakdown Voltage	AC, 50Hz(R.M.S), t=1minute	4000	V
CTI	Comparative Tracking Index		> 225	
Torque	to heatsink	Recommended (M6)	3~5	Nm
	to terminal	Recommended (M6)	2.5~5	Nm
Weight			300	g

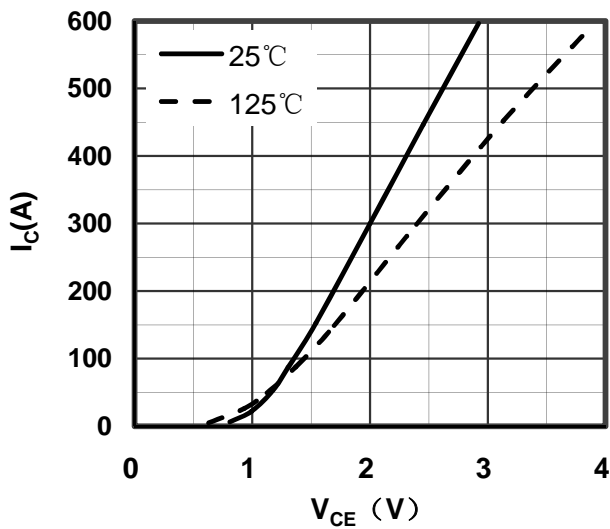

Figure 1. Typical Output Characteristics IGBT-inverter

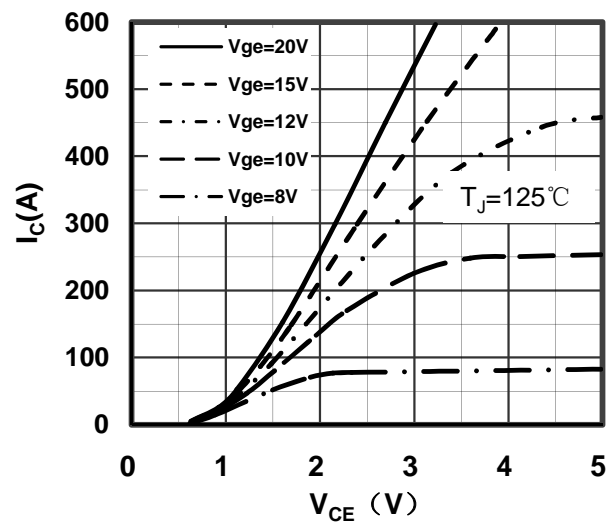

Figure 2. Typical Output Characteristics IGBT-inverter

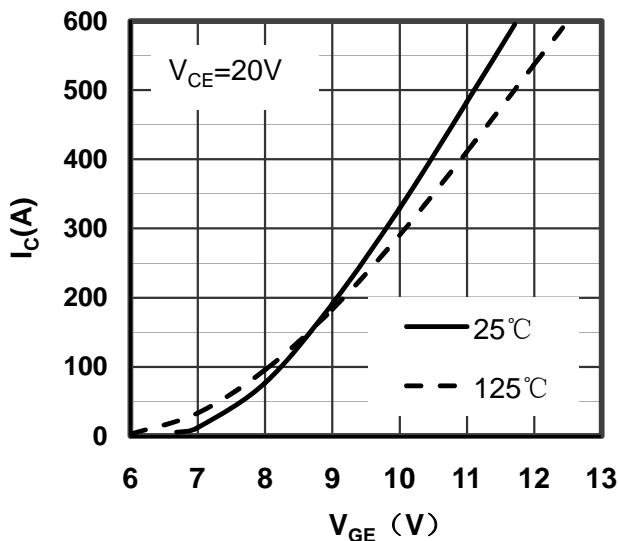

Figure 3. Typical Transfer Characteristics IGBT-inverter

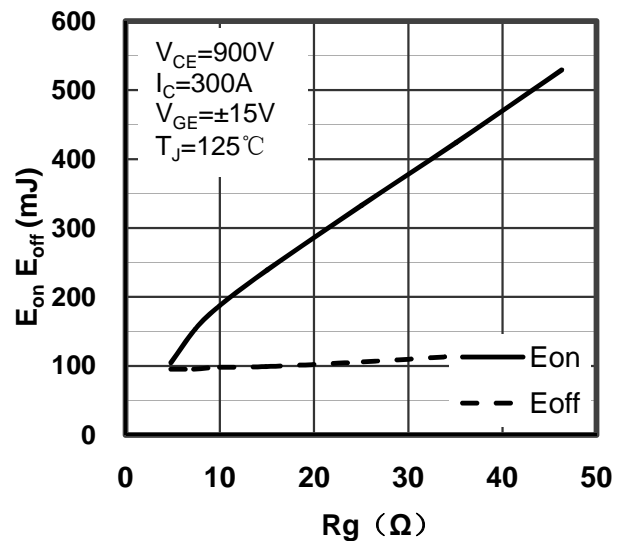

Figure 4. Switching Energy vs Gate Resistor IGBT-inverter

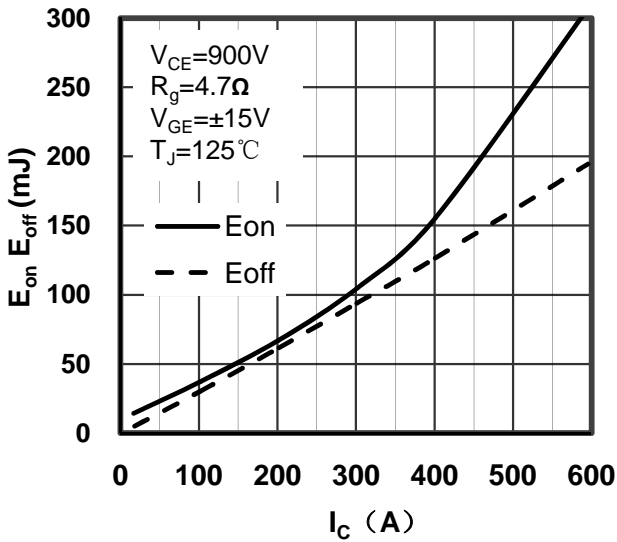

Figure 5. Switching Energy vs Collector Current IGBT-inverter

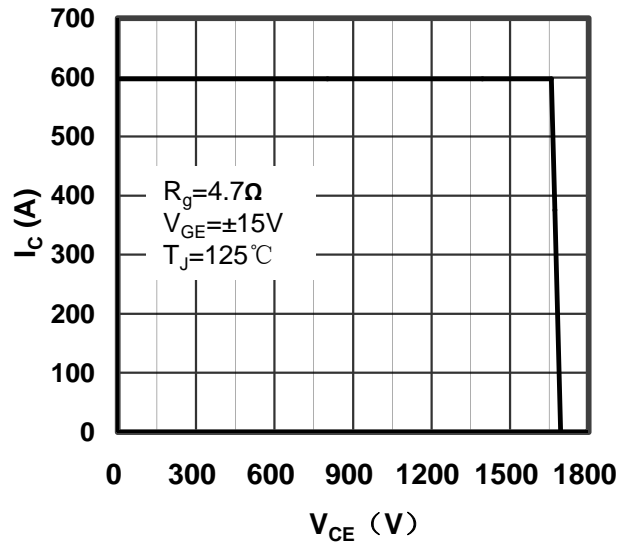

Figure 6. Reverse Biased Safe Operating Area IGBT-inverter

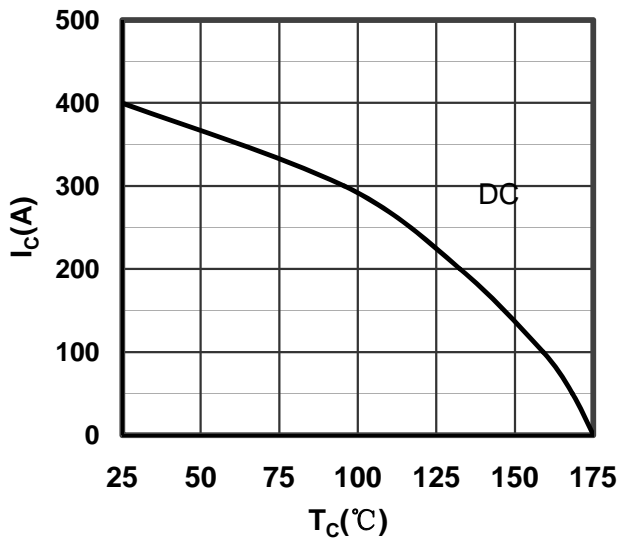

Figure 7. Collector Current vs Case temperature IGBT-inverter

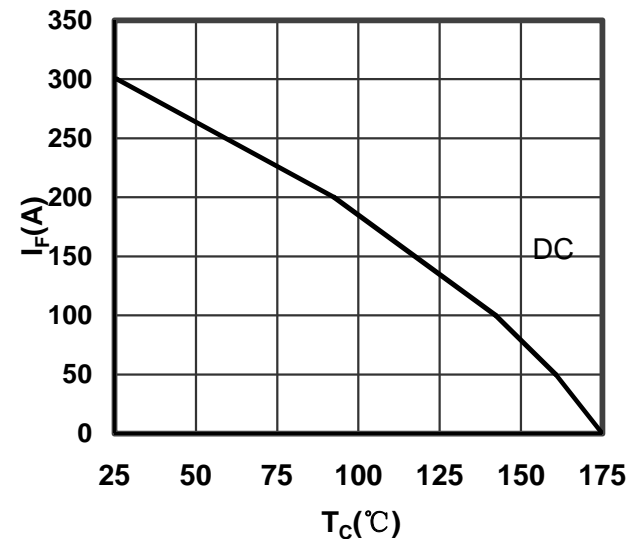

Figure 8. Forward current vs Case temperature Diode-inverter

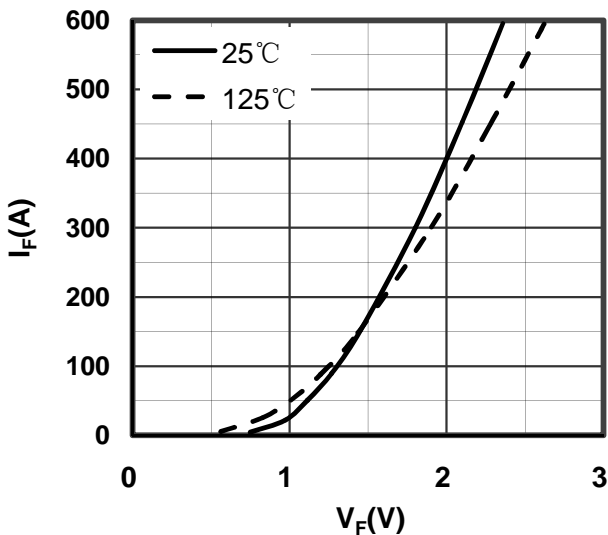

Figure 9. Diode Forward Characteristics Diode-inverter

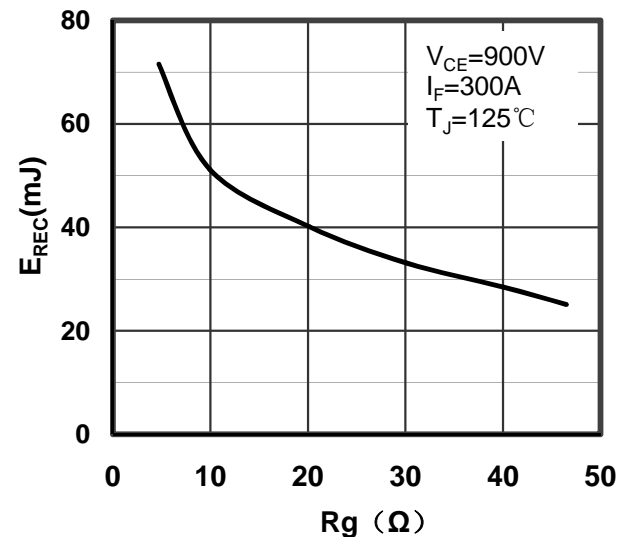

Figure 10. Switching Energy vs Gate Resistor Diode-inverter

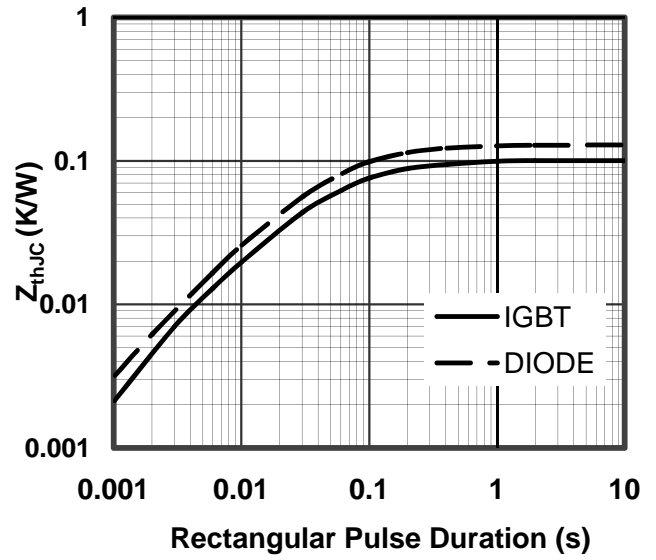
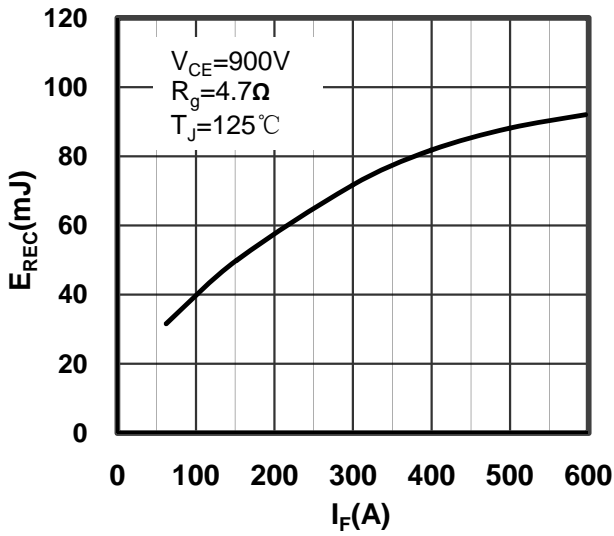

Figure 11. Switching Energy vs Forward Current Diode-inverter

Figure 12. Transient Thermal Impedance of Diode and IGBT-inverter

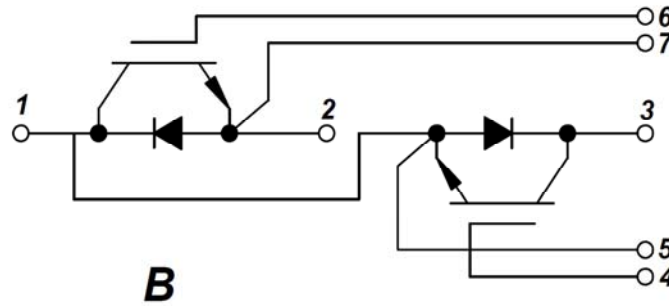
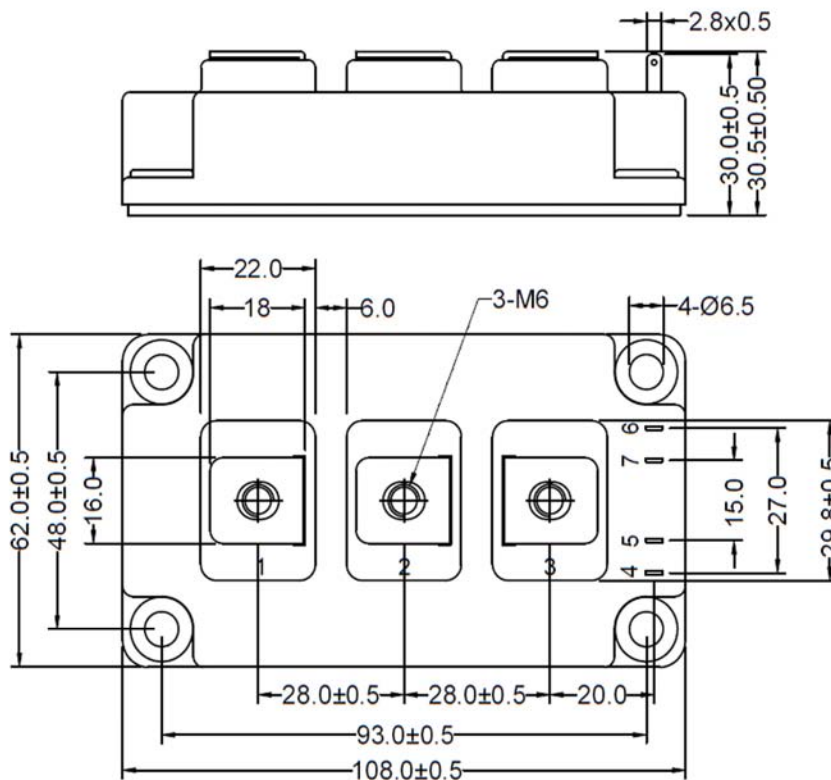

Figure 13. Circuit Diagram



Dimensions in (mm)  
Figure 14. Package Outline