

## PRODUCT FEATURES

- High short circuit capability, self limiting short circuit current
- IGBT CHIP(T4 Fast Trench+Field Stop technology)
- $V_{CE(sat)}$  with positive temperature coefficient
- Fast switching and short tail current
- Free wheeling diodes with fast and soft reverse recovery
- Low switching losses
- $T_{Jmax} = 175^{\circ}C$



## APPLICATIONS

- High frequency switching application
- Medical applications
- Motion/servo control
- UPS systems

## IGBT-inverter

### ABSOLUTE MAXIMUM RATINGS

$T_C = 25^{\circ}C$  unless otherwise specified

Symbol	Parameter/Test Conditions		Values	Unit
$V_{CES}$	Collector Emitter Voltage	$T_J = 25^{\circ}C$	1200	V
$V_{GES}$	Gate Emitter Voltage		$\pm 20$	
$I_C$	DC Collector Current	$T_C = 25^{\circ}C$	100	A
		$T_C = 95^{\circ}C$	75	
$I_{CM}$	Repetitive Peak Collector Current	$t_p = 1ms$	150	
$P_{tot}$	Power Dissipation Per IGBT		468	W

## Diode-inverter

### ABSOLUTE MAXIMUM RATINGS

$T_C = 25^{\circ}C$  unless otherwise specified

Symbol	Parameter/Test Conditions		Values	Unit
$V_{RRM}$	Repetitive Reverse Voltage	$T_J = 25^{\circ}C$	1200	V
$I_{F(AV)}$	Average Forward Current	$T_C = 25^{\circ}C$	75	A
$I_{FRM}$	Repetitive Peak Forward Current	$t_p = 1ms$	150	
$i^2t$		$T_J = 125^{\circ}C, t = 10ms, V_R = 0V$	1150	A <sup>2</sup> S

## IGBT-inverter

## ELECTRICAL CHARACTERISTICS

 $T_C=25^{\circ}\text{C}$  unless otherwise specified

Symbol	Parameter/Test Conditions		Min.	Typ.	Max.	Unit	
$V_{GE(th)}$	Gate Emitter Threshold Voltage	$V_{CE}=V_{GE}, I_C=3\text{mA}$	5.4	6.0	6.5	V	
$V_{CE(sat)}$	Collector Emitter Saturation Voltage	$I_C=75\text{A}, V_{GE}=15\text{V}, T_J=25^{\circ}\text{C}$		2.1	2.5		
		$I_C=75\text{A}, V_{GE}=15\text{V}, T_J=125^{\circ}\text{C}$		2.5			
$I_{CES}$	Collector Leakage Current	$V_{CE}=1200\text{V}, V_{GE}=0\text{V}, T_J=25^{\circ}\text{C}$			1	mA	
		$V_{CE}=1200\text{V}, V_{GE}=0\text{V}, T_J=125^{\circ}\text{C}$			10	mA	
$I_{GES}$	Gate Leakage Current	$V_{CE}=0\text{V}, V_{GE}=\pm 15\text{V}, T_J=25^{\circ}\text{C}$	-400		400	nA	
$R_{gint}$	Integrated Gate Resistor			10		$\Omega$	
$Q_g$	Gate Charge	$V_{CE}=600\text{V}, I_C=75\text{A}, V_{GE}=15\text{V}$		0.35		$\mu\text{C}$	
$C_{ies}$	Input Capacitance	$V_{CE}=25\text{V}, V_{GE}=0\text{V}, f=1\text{MHz}$		4.4		nF	
$C_{res}$	Reverse Transfer Capacitance				240		pF
$t_{d(on)}$	Turn on Delay Time	$V_{CC}=600\text{V}, I_C=75\text{A}$ $R_G=10\Omega,$ $V_{GE}=\pm 15\text{V},$ Inductive Load	$T_J=25^{\circ}\text{C}$		150		ns
			$T_J=125^{\circ}\text{C}$		160		ns
			$T_J=150^{\circ}\text{C}$		170		ns
$t_r$	Rise Time		$T_J=25^{\circ}\text{C}$		60		ns
			$T_J=125^{\circ}\text{C}$		65		ns
			$T_J=150^{\circ}\text{C}$		70		ns
$t_{d(off)}$	Turn off Delay Time	$T_J=25^{\circ}\text{C}$		360		ns	
		$T_J=125^{\circ}\text{C}$		400		ns	
		$T_J=150^{\circ}\text{C}$		420		ns	
$t_f$	Fall Time	$T_J=25^{\circ}\text{C}$		40		ns	
		$T_J=125^{\circ}\text{C}$		60		ns	
		$T_J=150^{\circ}\text{C}$		70		ns	
$E_{on}$	Turn on Energy	$V_{CC}=600\text{V}, I_C=75\text{A}$ $R_G=10\Omega,$ $V_{GE}=\pm 15\text{V},$ Inductive Load	$T_J=125^{\circ}\text{C}$		10		mJ
			$T_J=150^{\circ}\text{C}$		11		mJ
$E_{off}$	Turn off Energy		$T_J=125^{\circ}\text{C}$		4.5		mJ
			$T_J=150^{\circ}\text{C}$		4.8		mJ
$I_{sc}$	Short Circuit Current		$tp_{sc}\leq 10\mu\text{s}, V_{GE}=15\text{V}$ $T_J=125^{\circ}\text{C}, V_{CC}=600\text{V}$		300		A
$R_{thJC}$	Junction to Case Thermal Resistance ( Per IGBT )				0.32	K /W	

## Diode-inverter

## ELECTRICAL CHARACTERISTICS

 $T_C=25^{\circ}\text{C}$  unless otherwise specified

Symbol	Parameter/Test Conditions		Min.	Typ.	Max.	Unit
$V_F$	Forward Voltage	$I_F=75\text{A}, V_{GE}=0\text{V}, T_J=25^{\circ}\text{C}$		1.65	2.15	V
		$I_F=75\text{A}, V_{GE}=0\text{V}, T_J=125^{\circ}\text{C}$		1.65		
$t_{rr}$	Reverse Recovery Time	$I_F=75\text{A}, V_R=600\text{V}$		450		ns
$I_{RRM}$	Max. Reverse Recovery Current	$di_F/dt=-1650\text{A}/\mu\text{s}$		65		A
$Q_{RR}$	Reverse Recovery Charge	$T_J=125^{\circ}\text{C}$		13.5		$\mu\text{C}$
$E_{rec}$	Reverse Recovery Energy			5.1		mJ
$R_{thJCD}$	Junction to Case Thermal Resistance ( Per Diode )				0.6	K /W

**MODULE CHARACTERISTICS**

$T_C=25^{\circ}\text{C}$  unless otherwise specified

Symbol	Parameter/Test Conditions		Values	Unit
$T_{Jmax}$	Max. Junction Temperature		175	°C
$T_{Jop}$	Operating Temperature		-40~150	
$T_{stg}$	Storage Temperature		-40~125	
$V_{isol}$	Isolation Breakdown Voltage	AC, 50Hz(R.M.S), t=1minute	3000	V
CTI	Comparative Tracking Index		> 200	
Torque	to heatsink	Recommended (M6)	3~5	Nm
	to terminal	Recommended (M5)	2.5~5	Nm
Weight			160	g

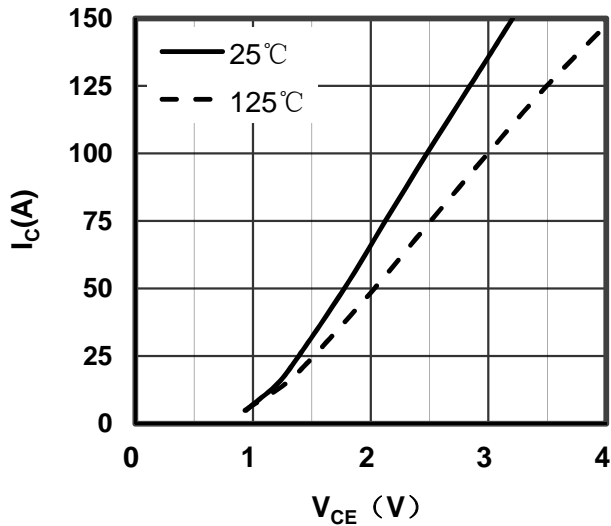

Figure 1. Typical Output Characteristics IGBT-inverter

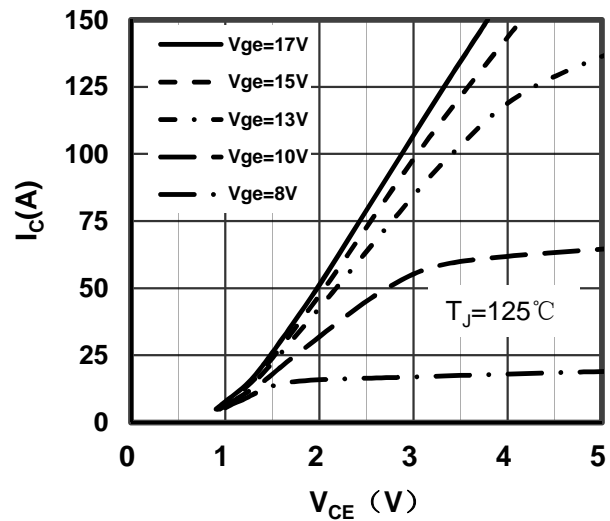

Figure 2. Typical Output Characteristics IGBT-inverter

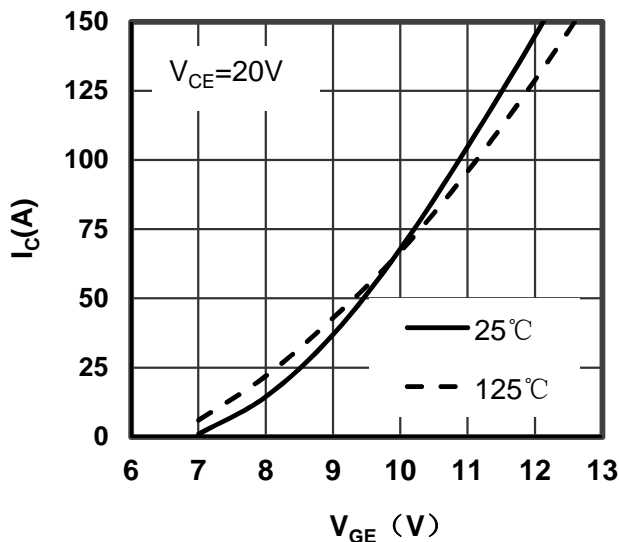

Figure 3. Typical Transfer characteristics IGBT-inverter

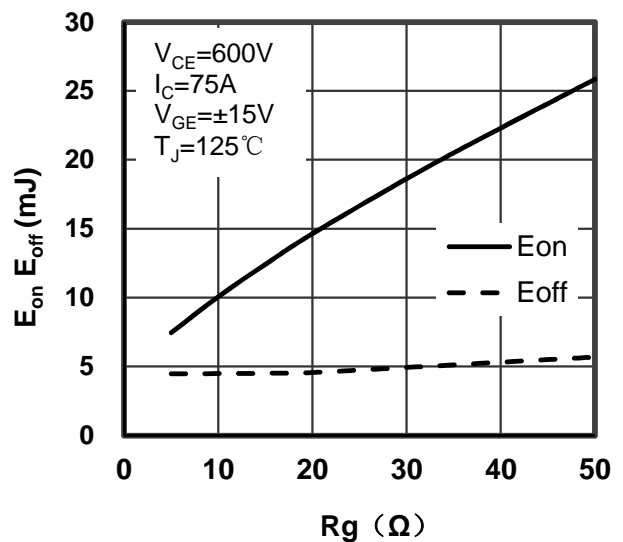

Figure 4. Switching Energy vs Gate Resistor IGBT-inverter

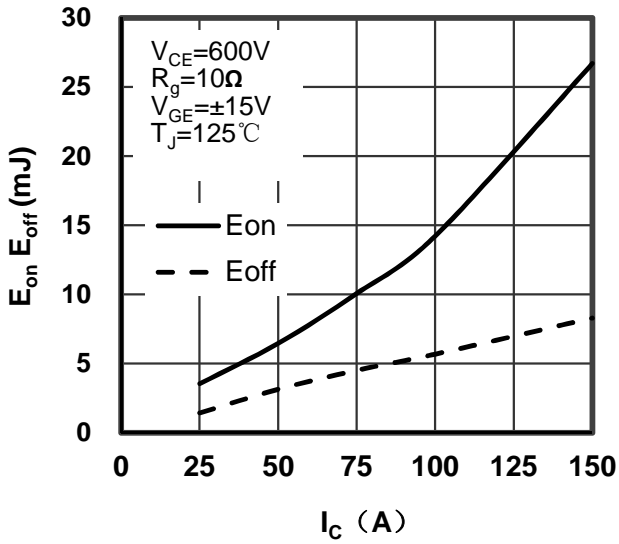

Figure 5. Switching Energy vs Collector Current IGBT-inverter

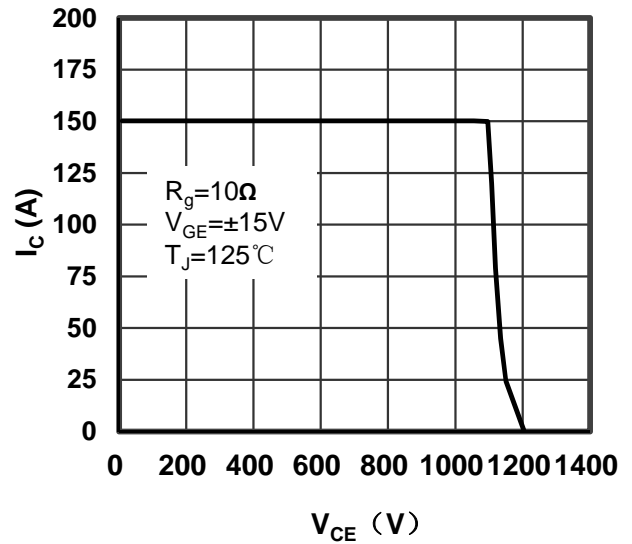

Figure 6. Reverse Biased Safe Operating Area IGBT-inverter

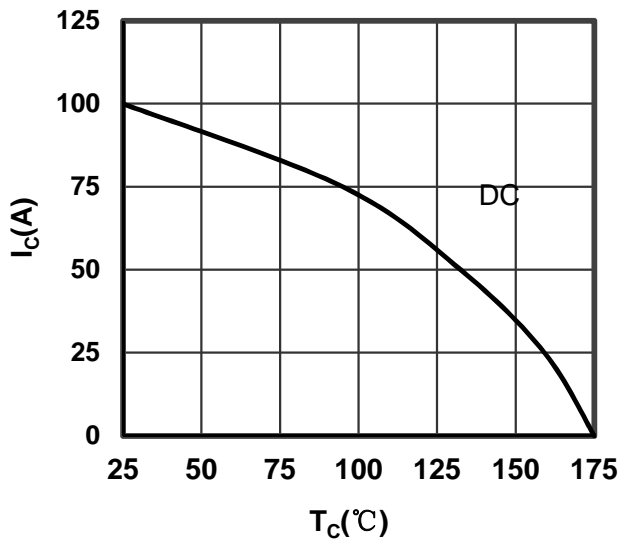

Figure 7. Collector Current vs Case temperature IGBT-inverter

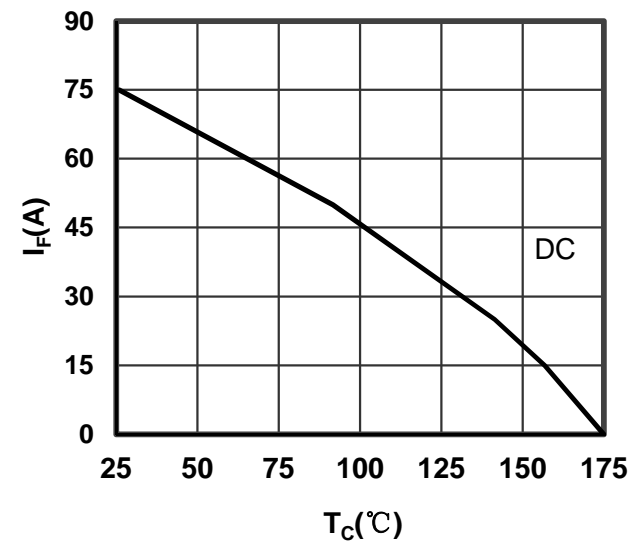

Figure 8. Forward current vs Case temperature Diode-inverter

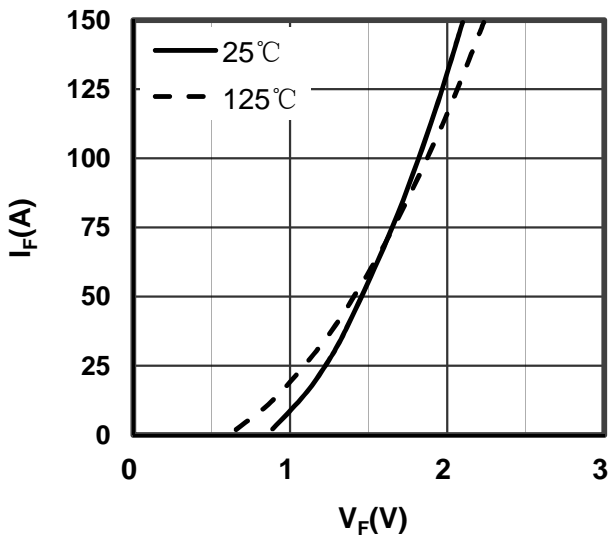

Figure 9. Diode Forward Characteristics Diode-inverter

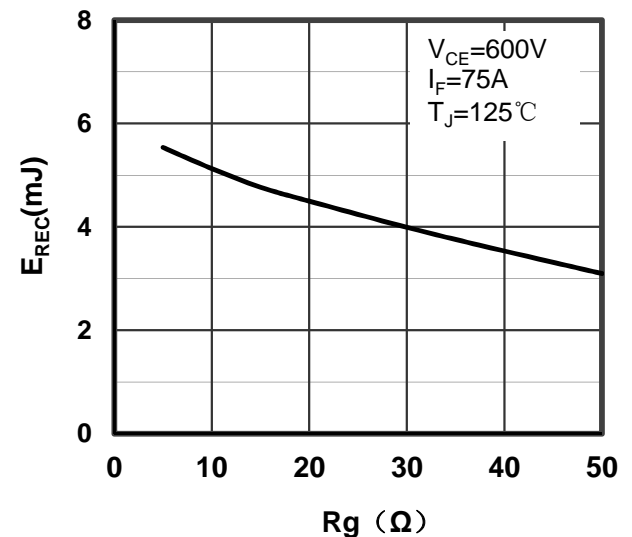

Figure 10. Switching Energy vs Gate Resistor Diode-inverter

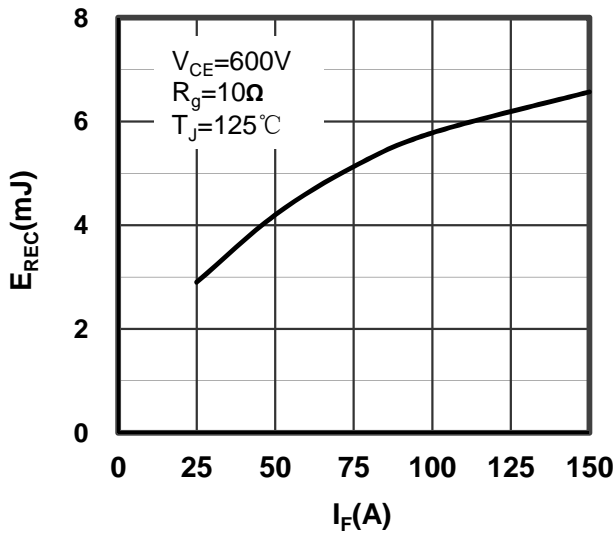

Figure 11. Switching Energy vs Forward Current Diode-inverter

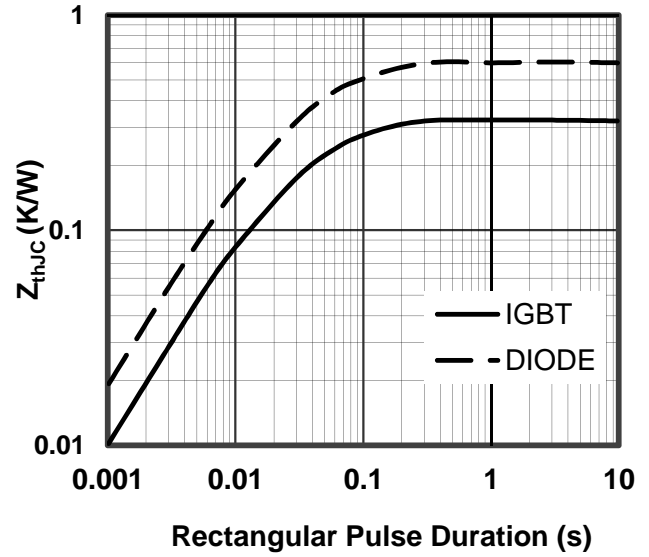

Figure 12. Transient Thermal Impedance of Diode and IGBT-inverter

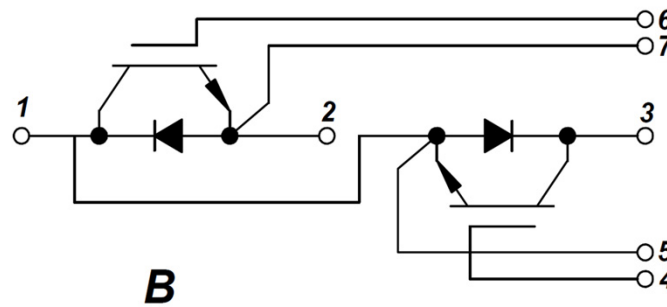

Figure 13. Circuit Diagram

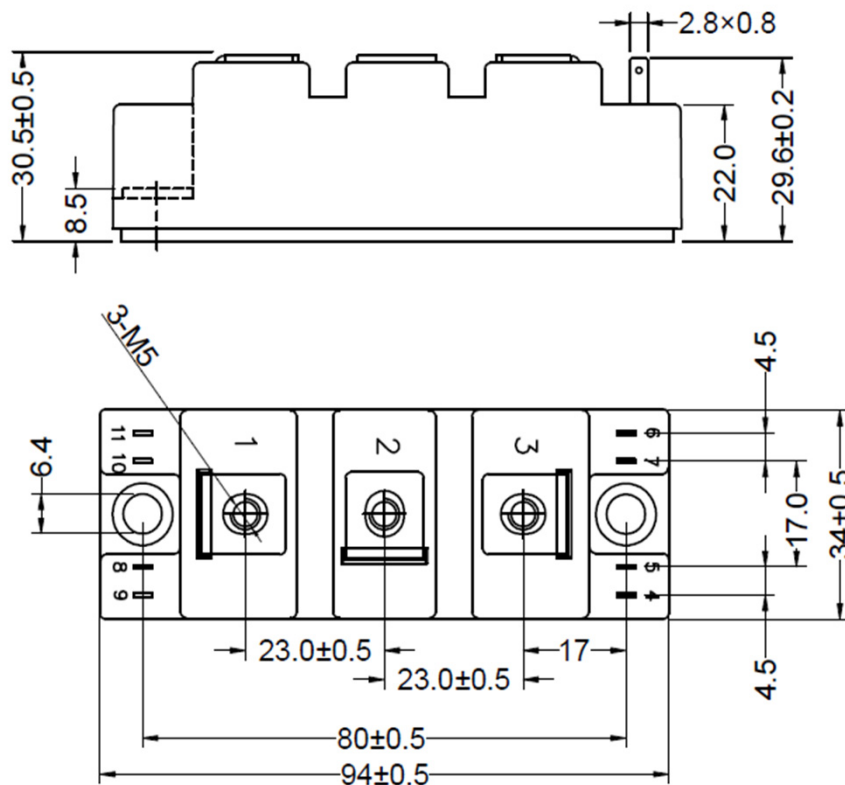

Figure 14. Package Outline